

THE PROCESS CONTROL UNIT



MODEL PCU INSTRUCTION MANUAL

INTRODUCTION

The Process Control Unit (PCU) is a multi-purpose series of industrial control products that are field-programmable for solving various applications. This series of products is built around the concept that the end user has the capability to program different personalities and functions into the unit in order to adapt to different indication and control requirements.

The PCU unit, which you have purchased, has the same high quality workmanship and advanced technological capabilities that have made Red Lion Controls the leader in today's industrial market.

Red Lion Controls has a complete line of industrial indication and control equipment, and we look forward to servicing you now and in the future.



CAUTION: Read complete instructions prior to installation and operation of the unit.



CAUTION: Risk of electric shock.

Table of Contents

GENERAL DESCRIPTION	1
Safety Summary	2
INSTALLATION & CONNECTIONS	3
Installation Environment	3
Standard Unit Installation	3
NEMA 4X/IP65 Unit Installation	3
Unit Removal Procedure	5
Removing Bezel Assembly	5
Installing Bezel Assembly	5
Output Modules	5
Output Module Restrictions	5
Installing Output Modules	6
Typical Connections	6
Select AC Power (115/230 VAC)	6
EMC Installation Guidelines	7
Wiring Connections	8
Valve Positioner Wiring	9
Linear DC Output Wiring	9
Second Analog Input Wiring	9
Program Disable Or User Input Wiring	10
AC Power Wiring	10
FRONT PANEL DESCRIPTION	11
Button Functions	11
OPERATION OVERVIEW	12
Controller Power-up	12
Controller Power Down	12
Process Start-up	12
Manual (User) & Automatic Operation	12
Remote And Local Setpoint Operation	13

Configuration Of Parameters	14
Parameter Entry	15
Normal Display Mode	15
Modifying A Secondary Display Parameter From The Front Panel	15
UNPROTECTED PARAMETER MODE	16
Unprotected Parameter Mode Reference Table	16
PROTECTED PARAMETER MODE	18
Protected Parameter Mode Reference Table	18
FRONT PANEL PROGRAM DISABLE	19
Models With User Input	19
Models With Program Disable	19
HIDDEN FUNCTION MODE	20
Hidden Function Mode Reference Table	20
CONFIGURATION PARAMETER MODULES	21
Input Module (1- In)	21
Input Type (tYPE)	21
Square Root Linearization (root) (Optional)	21
Decimal Point Position (dCpt)	21
Rounding Increment (rnd)	21
Input Signal Filter and Display Update Rate (FLtr)	22
Scaling Points	22
Display Values (dSP1 & dSP2)	22
Signal Input Values (INP1 & INP2)	22
Key-in Method	22
Signal Input Method	22
Setpoint Limit Values (SPLO & SPHI)	23
Setpoint Ramp Rate (SPrP)	23
Output Module (2-OP)	24
Time Proportioning Cycle Time (CYCt)	24
Output Control Action (OPAC)	24
Output Power Limits (OPLO & OPHI)	25

Input Overdrive Preset Power (OPFL)	25
Output Power Dampening (OPdP)	25
ON/OFF Control Hysteresis Band (CHYS)	25
Auto-Tune Dampening Code (tcod)	26
Linear DC Analog Output (ANAS, ANLO, ANHI, ANdb, ANUt) (Optional)	26
Lockouts Module (3-LC)	27
Lower Display Lockouts (SP, OP, IN-2, dEv, bdSP)	27
Protected Mode Lockouts (Code, PID, PID2, rtbS & AL)	28
Hidden Mode Lockouts (ALrS, trnF, tUNE and SPSL)	28
Alarm Module (4-AL) (Optional)	28
Alarm Action (Act1, Act2)	28
Second Analog Input Alarm	29
Valve Fail Alarm (VFAL)	29
Alarm Action Figures	30
Alarm Reset (rSt1, rSt2)	32
Alarm Standby Delay (Stb1, Stb2)	32
Alarm Value (AL-1, AL-2)	32
Alarm Hysteresis (AHYS)	33
Secondary Output Module (5-02) (Optional)	33
Time Proportioning Cycle Time (CYC2)	33
Relative Gain (GAN2)	33
Overlap/Deadband (db-2)	33
Serial Communications Module (6-SC) (Optional)	34
Baud Rate (bAUd)	34
Parity Bit (PArb)	34
Address Number (Addr)	34
Abbreviated or Full Transmission (Abrv)	34
Print Rate (PrAt)	34
Print Options (PoPt)	35
Second Analog Input Module (7-2N) (Optional)	35
Operation mode (OPEr)	35
Square Root Linearization (root)	35

Decimal Point Position (dPt2)	36
Second Analog Input Scaling Points (dSP1, INP1, dSP2, INP2)	36
Display Values (dSP1 & dSP2)	36
Signal Input Values (INP1 & INP2)	36
Key-in Method	36
Signal Input Method	36
Local/Remote Setpoint Transfer Modes (SPtr)	37
Secondary Output Power Dampening (OPd2)	37
Valve Positioner Module (8-VP)	37
Valve Position 1 And Valve Position 2 (VPS1, VPS2)	37
Valve Update Time (VUdt) (Position And Velocity Mode)	38
Valve Position Deadband (VPdb) (Position Mode)	38
Valve Fail Time Alarm (VFAL) (Position Mode)	38
Valve Motor Open Time And Valve Motor Close Time (VOpt, VCLt) (Velocity mode)	38
Valve Minimum On Time (VONt)(Velocity Mode)	38
Factory Service Operations Module (9-FS)	38
Reference Tables: Configuration Parameter Modules	39
Configure Module 1 - Input Parameters (1-IN)	39
Configure Module 2 - Output Parameters (2-OP)	40
Configure Module 3 - Lockout Parameters (3-LC)	41
Configure Module 4 - Alarms (4-AL)	42
Configure Module 5 - Secondary Output Parameters (5-O2)	43
Configure Module 6 - Serial Communications (6-SC)	44
Configure Module 7 - Second Analog Input (7-2N)	45
Configure Module 8 - Valve Positioner (8-VP)	45
Configure Module 9 - Factory Service Operations (9-FS)	46
RS485 SERIAL COMMUNICATIONS INTERFACE	47
Communication Format	47
Sending Commands And Data	47
Output Status	48
Receiving Data	50
Serial Connections	52

Terminal Descriptions	52
Connecting To A Host Terminal	53
Troubleshooting Serial Communications	53
VALVE POSITION OPTION	54
Position Mode Valve Control	54
Velocity Mode Valve Control	55
SECOND ANALOG INPUT OPTION	56
Remote Setpoint	56
Flow Ratio Control	56
Process Remote Setpoint Slave Control	56
Cascade Control	56
External Cascade Control	57
Internal Cascade Control	58
PID CONTROL	59
Proportional Band	59
Integral Time	59
Derivative Time	60
Output Power Offset (Manual Reset)	60
PID Adjustments	60
ON/OFF CONTROL	62
AUTO-TUNE	64
Initiate Auto-Tune	65
Auto-Tune Of Secondary Output (OP2) / Main Output (OP1) Systems	65
Auto-Tune Of Internal Cascade Controllers	65
Auto-Tune Of External Cascade Systems (Remote Setpoint)	66
APPENDIX “A” - APPLICATION EXAMPLES	67
Chemical Mixing Application	67
Flow Rate Programming Example	68
APPENDIX “B” - SPECIFICATIONS AND DIMENSIONS	69
APPENDIX “C” - TROUBLESHOOTING	73

Output Leakage Current	75
APPENDIX “D” - MANUAL TUNING	76
Open Loop Step Response Method	76
Closed Loop Cycling Method	77
APPENDIX “E” - CALIBRATION	78
Calibration Check	78
Voltage Reading Check	78
Current Reading Check	78
Linear DC Output Check	78
4 to 20 mA	78
0 to 10 VDC	78
Second Input Check	78
Second Analog Input Check	78
Valve Positioner Check	78
Calibration	79
Configure Step 9 - Factory Service Operations (9-Fs)	79
Voltage Calibration	79
Current Calibration	79
Analog Output Calibration (ANCL)	79
4 to 20 mA	79
0 to 10 VDC	79
Second Analog Input Calibration (2CAL)	80
Second Analog Input (Remote Setpoint)	80
Motorized Valve Positioner	80
APPENDIX “F”-USER PARAMETER VALUE CHART	81
APPENDIX “G” ORDERING INFORMATION	84

GENERAL DESCRIPTION

The PCU Controller accepts either a 0 to 10 VDC or a 4 to 20 mA DC input signal, precisely scales the process signal according to programmable scaling points, and provides an accurate output control signal (time proportional, linear, or valve positioning) to maintain a process at the desired control point. A comprehensive set of easy to use steps allows the controller to solve various application requirements.

The controller can operate in the PID control mode for both the main output and optional secondary output. On-demand auto-tune establishes the tuning constants. The PID tuning constants may be fine-tuned by the operator at any time and locked out from further modification. The controller employs a unique overshoot suppression feature that allows the quickest response without excessive overshoot. The unit can be transferred to operate in the manual mode, providing the operator with direct control of the output. The controller can also be programmed to operate in the ON/OFF control mode with adjustable hysteresis.

Dual 4-digit displays allow viewing of the measured value and setpoint simultaneously. Front panel indicators inform the operator of the controller and output status. Replaceable and interchangeable output modules (Relay, SSR Drive, or Triac) can be installed for the main control output, Alarm output(s), Secondary output, and Valve Positioner outputs.

Optional dual alarms can be configured to activate according to a variety of actions (Absolute HI or LO, Deviation HI or LO, Band IN or OUT, and Valve Fail Detect) with adjustable hysteresis. A standby feature suppresses the output during power-up until the process stabilizes outside the alarm region. An optional secondary output is available (for processes requiring cooling, pH balance, etc.) that provides increased control accuracy and response.

A linear 4 to 20 mA or 0 to 10 VDC output signal is available to interface with actuators, chart recorders, indicators, or other controllers. The type of Linear DC output is determined by the model ordered. (See *Ordering Information*, page 84, for available models.) The output signal can be digitally scaled and selected to transmit one of the following: % output power, measurement value deviation or setpoint value. For Linear DC control applications, the adjustable output demand dampening, output deadband, and output update time parameters expand the versatility of the PCU to final control devices.

The optional Motorized Valve Positioner directly controls the position of a valve by the use of twin outputs (open and close) to control the direction of motor rotation. The motor position defines the opening position at the valve. Two control modes are possible: position control, which makes use of the slidewire feedback signal supplied with the positioner and velocity control, in which no slidewire feedback signal is used. Parameters are provided to adjust the operation of the valve. These include:

- Valve activity hysteresis
- Valve update time
- Variable control dampening
- Slidewire signal fail action
- Adjustable valve position limits

The Valve Positioner PCU achieves tight process control; yet minimizes unnecessary valve activity. An alarm event output or display alarm can be programmed under loss of slidewire feedback or under valve fail detection.

The optional Second Analog Input (0 to 20 mA DC) can be configured as a Remote Setpoint signal or as a Secondary Process signal. Configuration of the Second Analog Input as a Remote Setpoint signal allows ratio control, master setpoint/multiple slave operation, and the ability to cascade the PCU with another controller (External Cascade). Configuration of the Second Input as a Secondary Process signal allows operation as a two-process cascade controller within a single unit (Internal Cascade). In either control mode, parameters are provided to scale, configure, communicate and monitor the activity of both analog inputs. A square law linearizer function can be used to linearize signals derived from flow transmitters.

The optional RS485 multi-drop serial communication interface provides two-way communication between a PCU unit and other compatible equipment such as a printer, a programmable controller, or a host computer. In multi-point applications the address number of each unit on the line can be programmed from zero to ninety-nine. Up to thirty-two units can be installed on a single pair of wires. The Setpoint value, % Output Power, Setpoint Ramp Rate, etc. can be interrogated or changed, by sending the proper command code via serial communications. Alarm output(s) may also be reset via the serial communications interface option.

A programmable User Input is available with RS485, Valve Position, and Second Analog Input models. The User Input can be programmed to perform a variety of controller functions.

An optional NEMA 4X/IP65 rated bezel is available for wash down applications and similar environments, when properly installed. Modern surface-mount technology, in-house assembly and testing, and high immunity to noise interference makes the controller extremely reliable in industrial environments.

SAFETY SUMMARY

All safety related regulations, local codes and instructions that appear in the manual or on equipment must be observed to ensure personal safety and to prevent damage to either the instrument or equipment connected to it. If equipment is used in a manner not specified by the manufacturer, the protection provided by the equipment may be impaired.

Do not use the PCU to directly command motors, valves, or other actuators not equipped with safeguards. To do so, can be potentially harmful to persons or equipment in the event of a fault to the unit. An independent and redundant temperature limit indicator with alarm outputs is strongly recommended. Red Lion Controls offers various units (such as an IMP, IMD1, or IMD2) that may be used for this purpose. The indicators should have input sensors and AC power feeds independent from other equipment.

INSTALLATION & CONNECTIONS

INSTALLATION ENVIRONMENT

The unit should be installed in a location that does not exceed the maximum operating temperature and provides good air circulation. Placing the unit near devices that generate excessive heat should be avoided.

Continuous exposure to direct sunlight may accelerate the aging process of the bezel.

The bezel should be cleaned only with a soft cloth and neutral soap product. Do not use solvents.

Do not use tools of any kind (screwdrivers, pens, pencils, etc.) to operate the keypad of the unit.

STANDARD UNIT INSTALLATION

Prepare the panel cutout to the dimensions shown in Figure 1, Panel Installation & Removal. Remove the panel latch and cardboard sleeve from the unit and discard the cardboard sleeve. The unit should be installed with the bezel assembly in place. Insert the unit into the panel cutout. While holding the front of the unit in place, push the panel latch over the rear of the unit so that the tabs of the panel latch engage in the slots on the case. The panel latch should be engaged in the farthest forward slots possible. Tighten the screws evenly until the unit is snug in the panel.

NEMA 4X/IP65 UNIT INSTALLATION

The optional NEMA 4X/IP65 PCU Controller provides a watertight seal in panels with a minimum thickness of 1/8 inch. The units meet NEMA 4X/IP65 requirements for indoor use, when properly installed. The units are intended to be mounted into an enclosed panel. Prepare the panel cutout to the dimensions shown in Figure 1, Panel Installation & Removal. Carefully apply the adhesive side of the panel gasket to the panel cutout. Remove the panel latch and cardboard sleeve from the unit. Discard the cardboard sleeve. The unit should be installed with the bezel assembly in place and the bezel screws tightened slightly. Insert the unit into the panel cutout. While holding the front of the unit in place, push the panel latch over the rear of the unit so that the tabs of the panel latch engage in the slots on the case. The panel latch should be engaged in the farthest forward slot possible. To achieve a proper seal, tighten the latch screws evenly until the unit is snug in the panel (Torque to approximately 7 in-lbs [79 N-cm]). Do NOT over-tighten the screws.

Note: The installation location of the controller is important. Be sure to keep it away from heat sources (ovens, furnaces, etc.), away from direct contact with caustic vapors, oils, steam, or any other process by-products in which exposure may affect proper operation.

Caution: Prior to applying power to the controller, the internal AC power selector switch must be set. Damage to the controller may occur if the switch is set incorrectly.

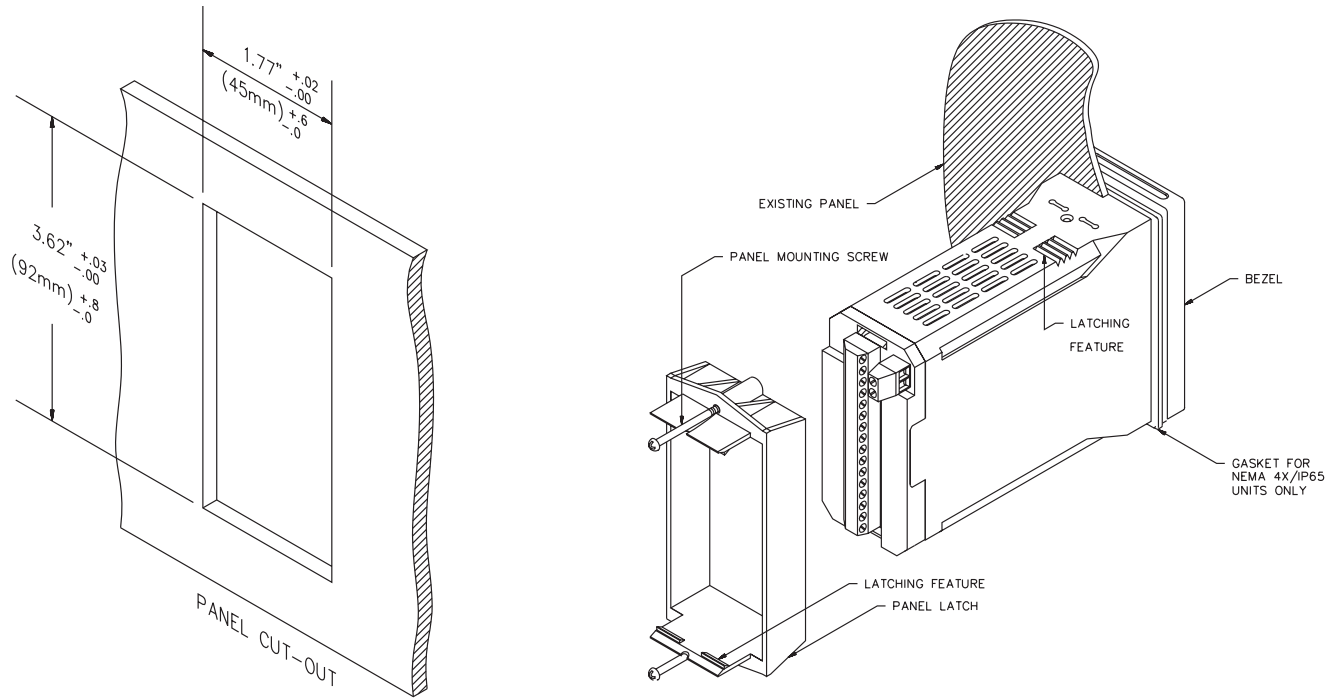

Figure 1, Panel Installation & Removal

UNIT REMOVAL PROCEDURE

To remove a NEMA 4X/IP65 or standard unit from the panel, first unscrew and remove the panel latch screws. Insert flat blade screwdrivers between the latch and the case on the top and bottom of the unit, so that the latches disengage from the grooves in the case. Push the unit through the panel from the rear.

REMOVING BEZEL ASSEMBLY

The bezel assembly, shown in Figure 2, must be removed from the case to install or replace output modules, or to set the 115/230 VAC selector switch. Disconnect power to the unit and to the output control circuits to eliminate the potential shock hazard when removing the bezel assembly. To remove a standard bezel assembly (without bezel securing screws), press the latch under the lower bezel lip and withdraw the bezel assembly. To remove the sealed NEMA 4X/IP65 bezel assembly, loosen the two bezel securing screws until a slight “click” is felt (the screws are retained in the bezel) and withdraw the assembly.

Caution: The bezel assembly contains electronic circuits that are damaged by static electricity. Before removing the assembly, discharge stray static electricity on your body by touching an earth ground point. It is also important that the bezel assembly be handled only by the bezel itself. Additionally, if it is necessary to handle a circuit board, be certain that hands are free from dirt, oil, etc., to avoid circuit contamination that may lead to malfunction. If it becomes necessary to ship the unit for repairs, place the unit in its case before shipping it.

INSTALLING BEZEL ASSEMBLY

To install the standard bezel assembly, insert the assembly into the case until the bezel latch snaps into position.

To install the NEMA 4X/IP65 bezel assembly, insert the assembly into the case and tighten the bezel screws uniformly until the bezel contacts the case and then turn each screw another half turn to insure a watertight seal (do not over-tighten screws).

Caution: When substituting or replacing a bezel assembly, be certain that it is done with the same model using the same Output Modules. Damage to the controller may result if the unit’s output modules are not the same. A NEMA 4X/IP65 and a standard bezel assembly are NOT interchangeable.

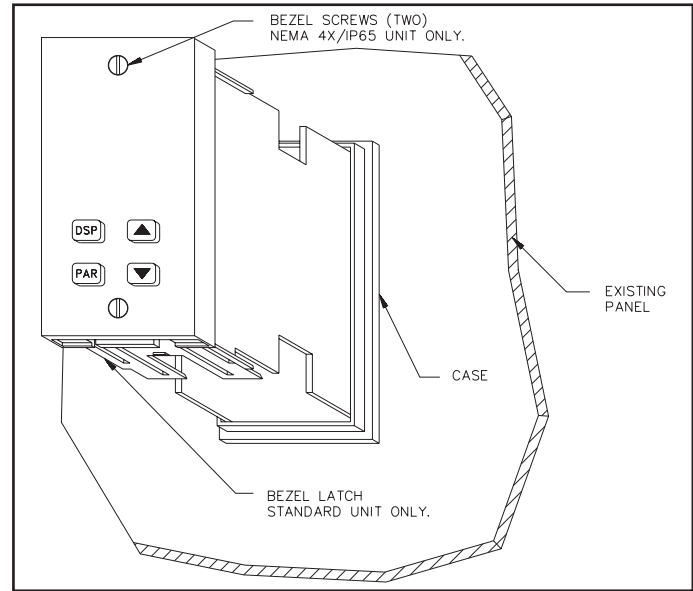

Figure 2, Bezel Assembly

OUTPUT MODULES

The main control, optional Alarm, optional Secondary output and optional Valve Position control output sockets must be fitted with the appropriate output module. Output modules are shipped separately and must be installed by the user.

Output Module Restrictions

With some models, the Alarm outputs and Valve Position outputs share the same common terminal. When using these models, the same type of output modules should be installed in these positions.

Installing Output Modules

To install an output module into the controller, remove the bezel assembly from the case (See *Removing Bezel Assembly*, page 5). Locate the correct output module socket (OP1, AL1, or AL2/OP2, see Figure 6, Hardware, or label outside of case) and plug the output module into the socket. No re-programming is required. If changing an output module type, be sure the appropriate output interface wiring changes are made. Re-install the bezel assembly when complete.

Note: For Valve Positioner models, the circuit board markings have the following meaning:

AL1 - Open Output

AL2/OP2 - Close Output

OP1 - Alarm #1 Output

OUTPUT MODULE "OUTPUT ON" STATE	
Relay	Normally open contact is closed
Logic/SSR Drive	Source is active.
Triac	Solid state switch is closed.

Typical Connections

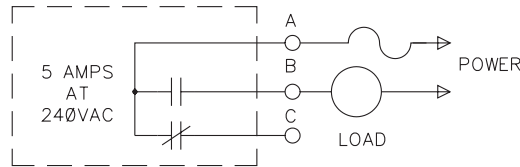

Figure 3, Relay Module

Relay:

Type: Form-C (Form A with some models. See Ordering Information.)

Rating: 5 Amps @ 120/240 VAC or 28 VDC (resistive load), 1/8 HP @ 120 VAC (inductive load).

Life Expectancy: 100,000 cycles at maximum load rating. (Decreasing load and/or increasing cycle time, increases life expectancy).

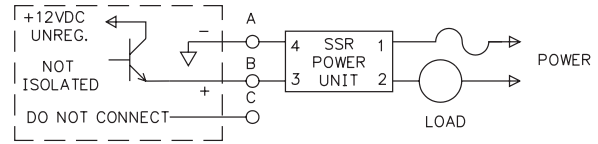

Figure 4, Logic/SSR Drive Module

Logic/SSR Drive:

Type: Non-isolated switched DC, 12 VDC typical

Drive: 45 mA Max. Can drive multiple SSR Power Units.

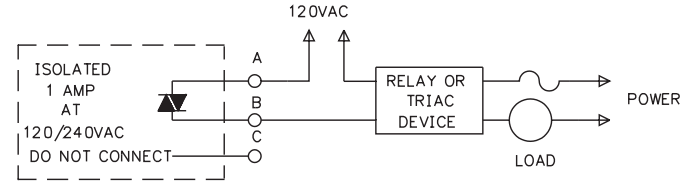

Figure 5, Triac Module

Triac:

Type: Isolated, Zero Crossing Detection.

Rating:

Voltage: 120/240 VAC.

Max. Load Current: 1 amp @ 35°C
0.75 amp @ 50°C

Min. Load Current: 10 mA

Off State Leakage Current: 7 mA maximum @ 60 Hz

Operating Frequency: 20 to 400 Hz

Protection: Internal Transient Snubber, Fused.

SELECT AC POWER (115/230 VAC)

The AC power to the unit must be selected for either 115 VAC or 230 VAC. The selector switch is located inside the case near the rear of the unit on the main circuit board (see Figure 6, Hardware, or label on outside of case). The unit is shipped from the factory with the switch in the 230 VAC position.

Caution: Damage to the controller may occur if the AC selector switch is set incorrectly.

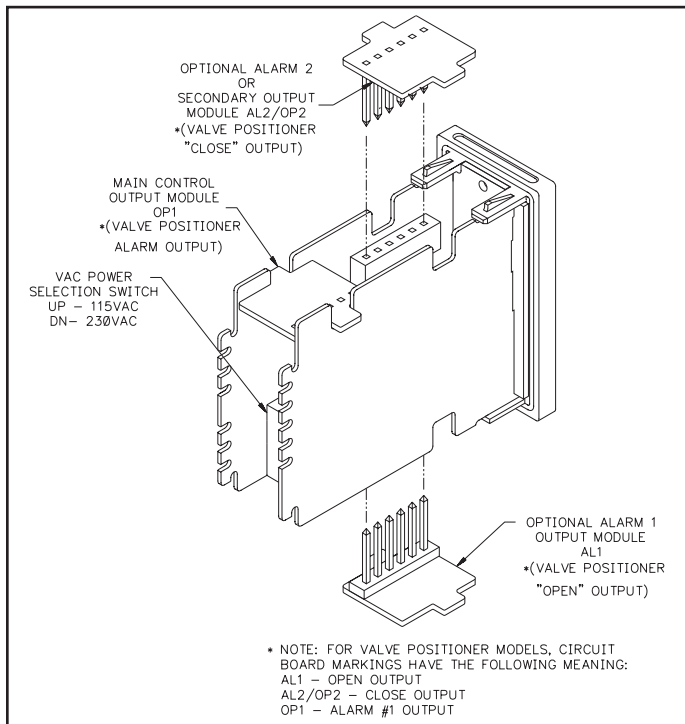

Figure 6, Hardware

EMC INSTALLATION GUIDELINES

Although this unit is designed with a high degree of immunity to ElectroMagnetic Interference (EMI), proper installation and wiring methods must be followed to ensure compatibility in each application. The type of electrical noise, source or coupling method into the unit may be different for various installations. In extremely high EMI environments, additional measures may be needed. The unit becomes more immune to EMI with fewer I/O connections. Cable length, routing and shield termination are very important and can mean the difference between a successful or a troublesome installation. Listed below are some EMC guidelines for successful installation in an industrial environment.

1. The unit should be mounted in a metal enclosure, which is properly connected to protective earth.
2. Use shielded (screened) cables for all Signal and Control inputs. The shield (screen) pigtail connection should be made as short as possible. The connection point for the shield depends somewhat upon the application. Listed below are the recommended methods of connecting the shield, in order of their effectiveness.
 - a. Connect the shield only at the panel where the unit is mounted to earth ground (protective earth).
 - b. Connect the shield to earth ground at both ends of the cable, usually when the noise source frequency is above 1 MHz.
 - c. Connect the shield to common of the unit and leave the other end of the shield unconnected and insulated from earth ground.
3. Never run Signal or Control cables in the same conduit or raceway with AC power lines, conductors feeding motors, solenoids, SCR controls, and heaters, etc. The cables should be run in metal conduit that is properly grounded. This is especially useful in applications where cable runs are long and portable two-way radios are used in close proximity or if the installation is near a commercial radio transmitter.
4. Signal or Control cables within an enclosure should be routed as far away as possible from contactors, control relays, transformers, and other noisy components.
5. In extremely high EMI environments, the use of external EMI suppression devices, such as ferrite suppression cores, is effective. Install them on Signal and Control cables as close to the unit as possible. Loop the cable through the core several times or use multiple cores on each cable for additional protection. Install line filters on the power input cable to the unit

to suppress power line interference. Install them near the power entry point of the enclosure. The following EMI suppression devices (or equivalent) are recommended:

Ferrite Suppression Cores for signal and control cables:

Fair-Rite # 0443167251 (RLC #FCOR0000)

TDK # ZCAT3035-1330A

Steward #28B2029-0A0

Line Filters for input power cables:

Schaffner # FN610-1/07 (RLC #LFIL0000)

Schaffner # FN670-1.8/07

Corcom #1VR3

Note: Reference manufacturer's instructions when installing a line filter.

6. Long cable runs are more susceptible to EMI pickup than short cable runs. Therefore, keep cable runs as short as possible.

7. Switching of inductive loads produces high EMI. Use of snubbers across inductive loads suppresses EMI.

Snubbers:

RLC #SNUB0000

WIRING CONNECTIONS

After the unit has been mechanically mounted, it is ready to be wired. All conductors should meet voltage and current ratings for each terminal. Also cabling should conform to appropriate standards of good installation, local codes and regulations. It is recommended that power supplied to the unit (AC or DC) be protected by a fuse or circuit breaker.

All wiring connections are made on a fixed terminal block. When wiring the unit, use the numbers on the label to identify the position number with the proper function. Strip the wire, leaving approximately 1/4" (6 mm) bare wire exposed (stranded wires should be tinned with solder). Insert the wire into the terminal and tighten the screw until the wire is clamped tightly. Each terminal can accept up to two, 18-gage wires. Wire each terminal block in this manner.

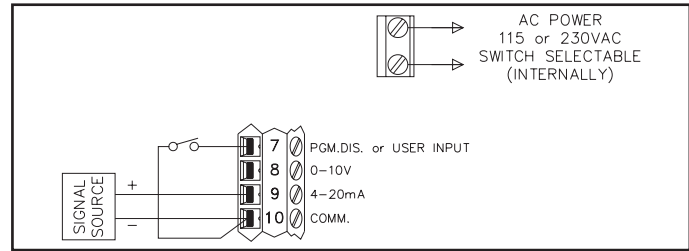

Figure 7, 4-20 mA Connection

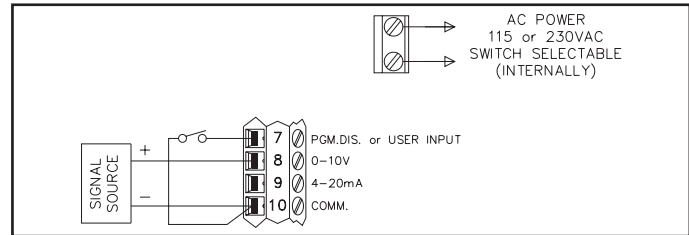

Figure 8, 0-10 V Connection

Valve Positioner Wiring

Units with Valve Positioner option have three output connections for controlling the valve motor and three input connections for slidewire feedback. The valve motor output connects to terminals labeled “Valve Position Outputs”, terminals 1, 2 and 3. See Figure 9, Valve Positioner Wiring for more details. Terminal 1 is the Valve motor supply common. Terminal 2 is the Valve Close or CW output. Terminal 3 is the Valve Open or CCW output. The valve motor must be fused with a suitable value.

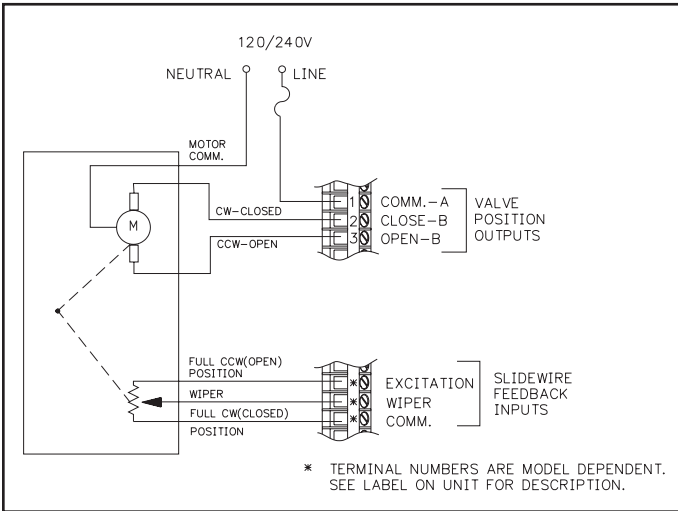

Figure 9, Valve Positioner Wiring

Although RC snubbers are employed inside the controller to suppress inductive “kicks” from the motor, it may be necessary to take further action to reduce noise effects:

1) Use Triac Output Modules wherever possible. The Triac device significantly reduces radiated EMI (Electromagnetic Interference).

The Triac Output Module also does not suffer from mechanical wear of the contacts.

- 2) Use RC snubbers directly across the valve motor.
- 3) Use a separate AC supply for the valve motor.

Where possible, the valve motor control outputs and the slidewire feedback input routing should be physically separated. Noise interference from the outputs could couple into the slidewire feedback inputs, disrupting proper operation.

The slidewire feedback inputs connect to the terminals labeled “Slidewire Feedback Inputs”. The terminal placement varies with each model, see the controller label for the actual terminals. For Velocity mode valve control the slidewire feedback inputs are not necessary.

In some cases, it may be desirable to have an independent valve position indicator. Red Lion Controls Model IMD1 can be wired in parallel with the slidewire input’s Wiper and Comm. terminals for this purpose. The approximate 0 to 0.9V signal can be scaled to indicate percent valve position.

Linear DC Output Wiring

Units with Linear DC output option have two terminals to output a 4 to 20 mA or 0 to 10 VDC signal. The type of Linear DC output is determined by the model ordered. (See *Ordering Information* page 84, for available models.) These terminals are labeled “4-20 mA (or 0-10 VDC) Analog Output Option, Out+ and Out-”. The common of this output is isolated from main input common, but is not isolated from the Second Analog Input Option common. For proper operation always keep these commons isolated.

Second Analog Input Wiring

Units with Second Analog Input option have two input terminals to receive a 4 to 20 mA signal. These terminals are labeled “Second Input, 4-20 mA+ and 4-20 mA-”. Terminal placement varies with model. See unit label for actual terminals. The common of this input is isolated from main input common, but is not isolated from the Linear DC Output common. For proper operation always keep these commons isolated.

Program Disable Or User Input Wiring

Some models have Terminal #7 as the User Input, which is programmable for a variety of functions. Other models have Terminal #7 dedicated to the program disable function. Any form of mechanical switch may be connected to terminal #7. Sinking open collector logic with less than 0.7 V saturation may also be used (no pull-up resistance is necessary).

Note: Do not tie the commons of multiple units to a single switch. Use either a multiple pole switch for ganged operation or a single switch for each unit.

AC Power Wiring

Primary AC power is connected to the separate two position terminal block labeled AC. To reduce the chance of noise spikes entering the AC line and affecting the controller, an AC feed separate from that of the load should be used to power the controller. Be certain that the AC power to the controller is relatively “clean” and within the -15%, +10% variation limit. Connecting power from heavily loaded circuits or circuits that also power loads that cycle on and off, (contacts, relays, motors, etc.) should be avoided.

FRONT PANEL DESCRIPTION

The front panel bezel material is flame and scratch resistant, tinted plastic. An optional NEMA 4X/IP65 bezel version is available that meets NEMA 4X/IP65 requirements, when properly installed. There are two 4-digit LED displays, a red upper Main Display and a lower green Secondary Display.

There are up to six annunciators depending on options installed, with red backlighting, that illuminate to inform the operator of the controller and output status. See Figure 10, Front Panel for a description of the available annunciators.

Four front panel buttons are used to access different modes and parameters. The following is a description of each button.

BUTTON FUNCTIONS

DSP - In the normal operating mode, the Display (DSP) button is used to select one of the operational parameters in the secondary display. In the Configuration Parameter Modes, pressing this button causes the unit to exit (escape) to the normal operating mode with no changes made to the selected parameter.

UP, DN - In the normal operating mode, the Up/Down buttons can be used to directly modify the setpoint value or % output power (manual mode only),

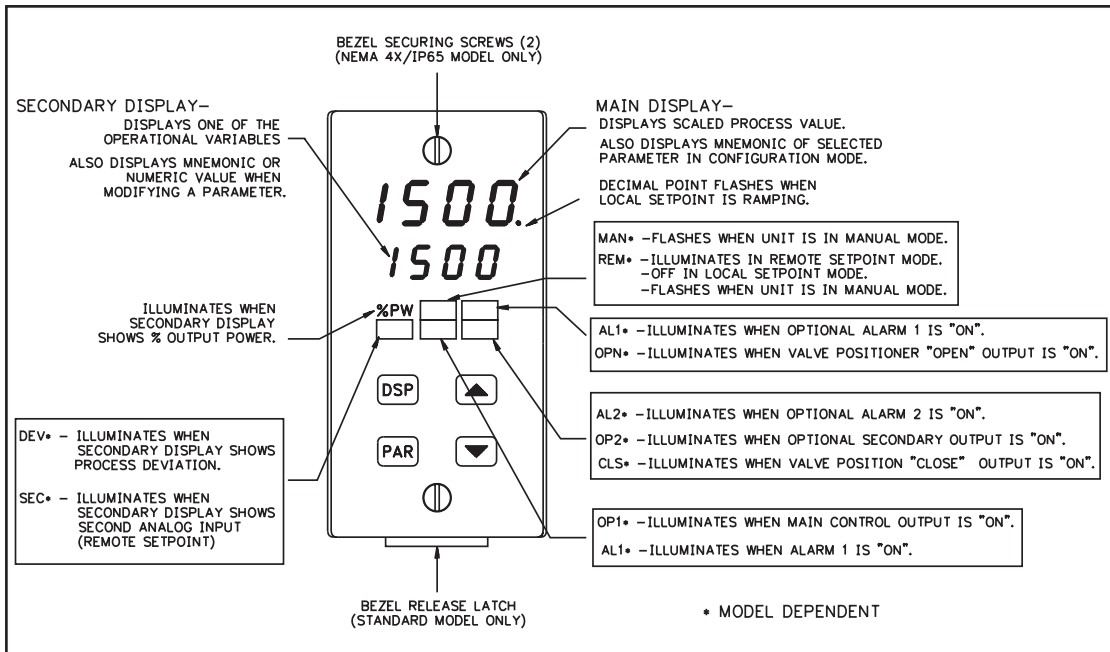

Figure 10, Front Panel

when viewed in the secondary display. Otherwise, the parameter must be called to alter the value.

PAR - The Parameter (PAR) button is used to access, enter the change, and scroll through the available parameters in any mode.

OPERATION OVERVIEW

CONTROLLER POWER-UP

Upon applying power, the controller delays control action and process indication for five seconds to perform several self-diagnostic tests and display basic controller information. Initially, the controller illuminates both displays and all annunciators to verify that all display elements are functioning. The controller then displays the programmed input type in the main display. Concurrently, it displays the current revision number of the operating system software in the bottom display. The controller checks for correct internal operation and displays an error message (E-XX) if an internal fault is detected (see *Troubleshooting*, page 73, for further information).

Upon completion of this sequence, the controller begins control action by displaying the process value and updating the outputs based upon the PID control calculation.

CONTROLLER POWER DOWN

At power down, the steady state control value as well as all parameters and control modes are saved, to provide a quick and predictable process response on the next power-up.

When powering down the process, it is important to power down the controller at the same time. This prevents the reset action of the controller from shifting the proportional band while the process signal is dropping and prevents excessive overshoot on the next process start-up.

PROCESS START-UP

After starting the process, the controller's PID settings must be initially "tuned" to the process for optimum control. Minimal tuning consists of adjusting the Proportional Band, Integral Time, and Derivative Time parameters to achieve the optimum response to a process disturbance. The controller can be tuned once, but must be re-tuned if the process has been changed significantly. Several options exist for tuning these parameters:

- A) Use the controller's built-in Auto-Tune feature (see *Auto-Tune*, page 64).
- B) Use a manual tuning technique (see *Manual Tuning*, page 76).
- C) Use a third party tuning software package (generally expensive and not always precise).
- D) Use values based on control loop experience, calculated values or values from a similar process.

If the controller is a replacement, the PID settings from the unit being replaced may be used as good initial values. Be sure to consider any differences in the units and the PID settings when replacing. The PID settings may be fine tuned by using the techniques outlined in the PID Control section. After tuning the controller to the process, it is important to power the load and the controller at the same time for best start-up response.

MANUAL (USER) & AUTOMATIC OPERATION

The controller can be transferred between Automatic control (closed loop; PID or ON/OFF control) and Manual control (open loop). In the Hidden Function Mode, the "trnf" parameter allows the operator to select the desired operating mode. To allow front panel switching between control modes, program the transfer (trnf) parameter to "Enbl" in the Lockout Module. The user input or RS485 serial interface option may also be used to perform the auto/manual transfer function, independent of the setting in the Lockout Module.

Manual operation provides direct control of the output(s) from 0 to +100%, or -100% to +100% if the secondary output is installed. For Valve Positioner models with slidewire feedback, this mode allows manual valve positioning. The MAN (REM for Remote Setpoint models) annunciator flashes to indicate that the unit is in manual operation.

When transferring the controller mode from/to automatic, the control power output(s) remain constant, exercising true "bumpless" transfer. When transferring from manual to automatic, the power initially remains steady but integral action corrects (if necessary) the closed loop power demand at a rate proportional to the Integral Time. The programmable high and low power limit values are ignored when the unit is in manual operation.

REMOTE AND LOCAL SETPOINT OPERATION

The controller setpoint mode can be switched between Local Setpoint operation and Remote Setpoint operation. In the Hidden Function Mode, the “SPSL” parameter allows the operator to select the desired setpoint operating mode. To allow front panel switching between setpoint modes, program the setpoint select parameter (SPSL) to “Enbl” in the Lockout Module. The user input or RS485 serial interface option may also be used to perform the setpoint selection function, independent of the setting in the Lockout Module. Front panel annunciator REM is on for Remote setpoint operation and is *off* for Local setpoint operation. When transferring the controller mode from/to the setpoint modes, various controller response options are available (see *SPtr parameter*, page 37).

CONFIGURATION OF PARAMETERS

As supplied from the factory, the controller parameters have been programmed to the values listed in the Programming Quick Reference Tables. The user must modify the values, if necessary, to suit the application.

Operation and configuration of the controller is divided into five distinct operational/programming modes to simplify the operation of the controller: Normal Display Mode, Unprotected Parameter Mode, Protected Parameter Mode, Hidden Function Mode, and Configuration Parameter Modules. See Figure 11, Operational/Programming Modes.

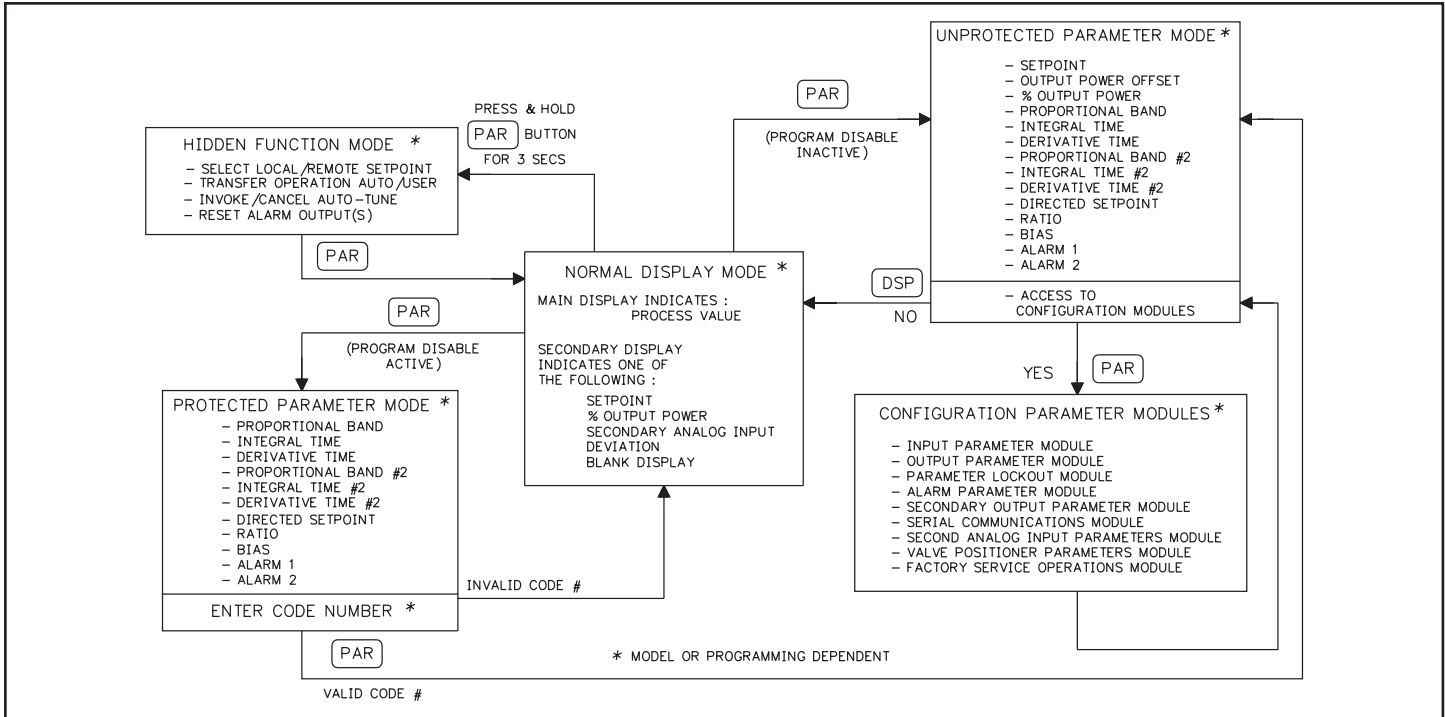

Figure 11, Operational/Programming Modes

PARAMETER ENTRY

The PAR button is used to select the desired parameter. To modify the parameter setting, use the UP and DOWN buttons. Press PAR to enter the new value. The controller progresses to the next parameter. In a Configuration Parameter Module, pressing the DSP button causes the new value to be rejected, the controller displays “End”, and returns to the Normal Display Mode. For those parameters outside the Configuration Parameter Modules, the new value takes effect and is committed into controller memory WHILE the value is keyed in. The following is a list of commonly modified parameters:

- Setpoint
- Output Power
- Output Power Offset
- Proportional Band
- Integral Time
- Derivative Time
- Proportional Band #2
- Integral Time #2
- Derivative Time #2
- Directed Setpoint (Cascade)
- Ratio
- Bias
- Alarm 1 Value
- Alarm 2 Value

Note: While in a Configuration Parameter Module, all new parameters are rejected and the old ones recalled if power is removed from the controller. If power is removed while modifying any parameter, be certain to check the parameter for the proper value.

NORMAL DISPLAY MODE

In the normal display mode, the process value is always displayed in the main display. By successively pressing the DSP button, one of these operational parameters can be viewed in the secondary display (model dependent):

- Setpoint
- % Output Power
- Second Analog Input (Remote Setpoint)
- Process Setpoint Deviation

Each of these displays can be independently locked out from appearing or from being modified by the user (see *Lockouts Module*, page 27). Only from the normal display mode can access be gained to the other modes (Unprotected, Protected, or Hidden).

MODIFYING A SECONDARY DISPLAY PARAMETER FROM THE FRONT PANEL

The controller must be in the normal display mode to modify the secondary display parameters. The Setpoint value and % output power (in manual mode) are the two parameters which may be modified. The other parameters are read-out values only.

Setpoint Value - Use the up and down arrow buttons to modify the setpoint value when viewed, if not locked. If locked, the setpoint can be changed in the unprotected mode when “SP” is viewed, independent of viewing in the secondary display. The setpoint value is confined to the programmable setpoint limit values (SPLO & SPHI, Input Module 1).

% Output Power - The % Output Power can only be changed when the unit is in the manual mode. See *Manual (User) and Automatic Operations*, page 12. The annunciator % PW lights, and the Manual annunciator flashes when viewed. Use the up and down arrow buttons to modify the % Output Power if not locked. If locked, the % output power can be changed in the unprotected mode when “OP” is viewed, independent of viewing in the secondary display. The % output power is not confined to the programmable output power limit values (OPLO & OPHI, Output Module 2).

UNPROTECTED PARAMETER MODE

The Unprotected Parameter Mode is accessed by pressing the PAR button from the normal display mode with program disable inactive. In this mode, the operator has access to the list of the most commonly modified controller parameters. At the end of the list, a configuration “access point” allows the operator to enter the configuration parameter modules. These modules allow access to the fundamental set-up parameters of the controller. When the program list has been scrolled through, the controller displays “End” and returns to the normal display mode. The unit automatically returns to the normal display mode if no action is taken.

UNPROTECTED PARAMETER MODE REFERENCE TABLE

Display	Parameter	Range and Units (Factory Setting Value)	Description/ Comments
SP	Setpoint	Confined to range of limits SPLO, SPHI, (0)	Appears only if setpoint value is locked (LOC) or read only (rEd).
OPOF	%Output Power Offset	-99.9% to 100.0% (0.0)	Appears only if integral time (Intt) = 0 and controller is in automatic mode.
OP	Output Power	-99.9% to 100.0% (0.0)	Appears only if controller is in user (manual) mode and % output power is locked (LOC) or read only (rEd). This parameter is not limited to output power limits (OPLO & OPHI).
Prop	Proportional Band	0.0 to 999.9% of scaled input range (4.0)	0.0% is ON/OFF control. If using ON/OFF mode, set control hysteresis appropriately.
Intt	Integral Time	0 to 9999 sec. (120)	0 is off. This parameter does not appear if proportional band = 0.0%.
dErt	Derivative Time	0 to 9999 sec. (30)	0 is off. This parameter does not appear if proportional band = 0.0%.
Pb-2	Proportional Band #2 (Secondary)	0.0 to 999.9% of Scaled input range (4.0)	0.0% is ON/OFF control. Second Analog Input models only.
It-2	Integral Time #2 (Secondary)	0 to 9999 sec (0)	0 is off. This parameter does not appear if proportional band #2 = 0.0%. Second Analog Input models only.

Display	Parameter	Range and Units (Factory Setting Value)	Description/ Comments
dt-2	Derivative Time #2 (Secondary)	0 to 9999 sec (0)	0 is off. This parameter does not appear if proportional band #2 = 0.0%. Second Analog Input models only.
SP-2	Internal Cascade Directed Setpoint	-999 to 9999 (N/A)	Second Analog Input models only. Read only parameter.
rtio	Remote Setpoint ratio multiplier	0.001 to 9.999 (1.000)	Second Analog Input models.
BIAS	Remote Setpoint bias offset	-999 to 9999 (0)	Second Analog Input models.
AL-1	Alarm 1 Value	-999 to 9999 (0)	Alarm option models only.
AL-2	Alarm 2 Value	-999 to 9999 (0)	This parameter does not appear if the alarm option is not specified, the secondary output option is installed, or if locked (LOC).
CNFP	Configuration Access Point	NO 1-IN 2-OP 3-LC 4-AL 5-02 6-SC 7-2N 8-VP 9-FS	Return to normal display mode. Enter Configuration modules. Configure input parameters. Configure output parameters. Configure parameter lockouts. Configure alarm parameters (opt.) Configure secondary output (opt.) Configure serial communication parameters (optional). Configure second analog input parameters (optional) Configure valve positioner parameters (optional) Factory service operations (Qualified technicians only)
End	Unit returns to Normal Display Mode	---	Brief display message.

PROTECTED PARAMETER MODE

The Protected Parameter Mode is accessed from the normal display mode by pressing the PAR button with program disable active. In this mode, the operator has access to the list of the most commonly modified controller parameters that have been “unlocked” in the configuration parameter lockouts module. Depending on the code number entered in the lockout

module, access to the unprotected parameter mode and hence, the configuration parameter modules is possible. The controller returns to the normal display mode if the unprotected mode and configuration modules cannot be accessed. This mode cannot be accessed if all parameters are locked out in Configuration Module 3.

PROTECTED PARAMETER MODE REFERENCE TABLE

Display	Parameter	Range and units (Factory Setting Value)	Description/Comments
Prop	Proportional Band	0.0 to 999.9% of scaled input range (4.0)	0.0% is ON/OFF control. If using ON/OFF mode, set control hysteresis appropriately. This parameter does not appear if locked (LOC).
Innt	Integral Time	0 to 9999 sec. (120)	0 is off. This parameter does not appear if proportional band = 0.0% or locked (LOC).
dErt	Derivative Time	0 to 9999 sec. (30)	0 is off. This parameter does not appear if proportional band = 0.0% or locked (LOC).
Pb-2	Proportional Band #2 (Secondary)	0.0 to 999.9% of scaled input range (4.0)	0.0% is ON/OFF control. Second Analog Input models only.
It-2	Integral Time #2 (Secondary)	0 to 9999 sec. (0)	0 is off. This parameter does not appear if proportional band #2= 0.0%, or if locked (LOC). Second Analog Input models only.
dt-2	Derivative Time #2 (Secondary)	0 to 9999 sec. (0)	0 is off. This parameter does not appear if proportional band #2= 0.0%, or if locked (LOC). Second Analog Input models only.
SP-2	Internal Cascade Directed Setpoint	-999 to 9999 (N/A)	Second Analog Input models only. Read only parameter.

Display	Parameter	Range and units (Factory Setting Value)	Description/Comments
rRio	Remote setpoint ratio multiplier	0.001 to 9.999 (1.000)	Second Analog Input models only.
blAS	Remote setpoint bias offset	-999 to 9999 (0)	Second Analog Input models only.
AL-1	Alarm 1 value	-999 to 9999 (0)	Alarm option models only.
AL-2	Alarm 2 value	-999 to 9999 (0)	This parameter does not appear if the alarm option is not specified, the secondary output option is installed, or if locked (LOC).
Code	Access code to unprotected mode	0 to 250 (0)	To gain access to unprotected mode, enter the same value for Code as entered in parameter lockouts. This parameter does not appear if zero is entered in code parameter lockout.
End	Unit returns to normal display mode.		Brief display message display mode.

FRONT PANEL PROGRAM DISABLE

There are several ways to limit the programming of parameters from the front panel buttons. The settings of the parameters in the Lockout Module, the code number entered, and the state and/or function programmed for the User Input (Terminal #7) affect front panel access.

It is possible to have the program disable function on versions with the User Input, even if the User Input is not programmed for program disable (PLOC), by the use of a code number. Versions that do not have the User Input are dedicated to the program disable function.

The following charts describe the possible program disable settings depending on your model.

MODELS WITH USER INPUT

User Input State	Code Number	Description
Inactive or User Input not programmed for PLOC	0	Full access to all modes and parameter modules.
Active with User Input programmed for PLOC	0	Access to protected parameter mode only. Code number does not appear.
Active with User Input programmed for PLOC OR User Input not programmed for PLOC	Any # between 1 & 250	Access to protected parameter mode. Correct programmed code number allows access to unprotected parameter mode and configuration modules.

Note: A universal code number 222 can be entered to gain access to the unprotected mode and configuration modules, independent of the programmed code number.

MODELS WITH PROGRAM DISABLE

Program Disable	Code Number	Description
Inactive	0	Full access to all modes and parameter modules.
Active	0	Access to protected parameter mode only. Code number does not appear.
Active	Any # between 1 & 250	Access to protected parameter mode. Correct programmed code number allows access to unprotected parameter mode and configuration modules.

Note: A universal code number 222 can be entered to gain access to the unprotected mode and configuration modules, independent of the programmed code number.

HIDDEN FUNCTION MODE

The Hidden Function Mode is only accessible from the normal display mode by pressing and holding the PAR button for three seconds. These functions must be unlocked in Configuration Module #3. Factory settings are locked. In this mode, these controller functions can be performed.

- Local/Remote Setpoint Selection
- Automatic/Manual Transfer
- Initiate/Cancel Auto-tune
- Reset Alarm Events

Each function may be “locked out” in the Configuration parameter lockouts module. The PAR button is used to scroll to the desired function and the up and down buttons are used to select the operation. Pressing the PAR button while the function is displayed executes the function, and returns the unit to the normal display mode. Pressing the DSP button exits this mode with no action taken. The unit automatically returns to the normal display mode if no action is taken.

HIDDEN FUNCTION MODE REFERENCE TABLE

Display	Parameter	Range and Units (Factory Setting Value)	Description/Comments
SPSL	Select Local or Remote Setpoint	LOC - Local Setpoint rE_t - Remote Setpoint (LOC)	Appears only for models with Second Analog Input. “SPtr” determines nature of controller response.
trnF	Transfer mode of operation	Auto - Automatic control User - Manual control (Auto)	This step does not appear if locked (LOC). Exits to normal display mode if executed.
tUNE	Auto-tune invocation	Yes: starts the auto-tune sequence. No: terminates the auto-tune sequence. Pr1 - tune primary (Cascade) SEC - tune secondary (Cascade) (NO)	This step does not appear if locked (LOC) or exits to normal display mode if executed. These parameters appear only if Second Analog Input Internal Cascade is selected.
ALrS	Alarm reset	UP key resets Alarm 1 DOWN key resets Alarm 2	This step does not appear if alarm option not installed, if locked (LOC) or previous step performed.

CONFIGURATION PARAMETER MODULES

Accessible from the unprotected parameter mode, the configuration parameter modules allow the operator access to the controller's fundamental set-up parameters. There are nine possible configuration stages that can be accessed. At the configuration stage access point "CNFP", the operator uses the UP & DOWN arrow buttons to select the desired configuration parameter module. Press the PAR button to enter the module where the settings can be viewed or modified. The PAR button is used to scroll through the parameters and the UP and DOWN buttons are used to modify the parameter value. The PAR button enters the desired choice, advancing to the next parameter. The operator can press the DSP button to exit (escape) without modifying the parameter. The unit returns to the normal display mode. After the parameters in a module are viewed or modified, the unit returns to the configuration access point, allowing access to other modules.

INPUT MODULE (1- IN)

The controller has several input set-up parameters that must be programmed prior to setting any other controller parameters.

Input Type (tYPE)

Select the signal input type Voltage (VOLt), or Current (Curr). The appropriate signal input terminal for voltage is #8 and for current is #9.

Square Root Linearization (root) (Optional)

The main input can be linearized by use of the square root function. See *Square Root Linearization*, page 35, for a complete description of the square root function.

The "root" parameter in Program Module 1 applies to the main input, and the "root" parameter in Program Module 7 applies to the Second Analog Input.

Decimal Point Position (dCpt)

Select the desired decimal point position for the scaled display. The selected decimal point position appears in the following parameters; rnd, dSP1, dSP2, SPLO, SPHI, SP, AL1, AL2, db-2, AHYS, and CHYS.

0
0.0
0.00
0.000

Rounding Increment (rnd)

Rounding values other than "1" causes the scaled number to 'round' to the nearest rounding increment selected (ie. rounding of '5' cause '122' to round to '120' and '123' to round to '125'). If the process is inherently jittery, the display value may be rounded to a higher value than "1". If the range of the process exceeds the required resolution, (ex. 0-1000 PSI, but only 10 PSI resolution required), a rounding increment of 10 will effectively make the display more stable.

This programming step is usually used in conjunction with programmable digital filtering to help stabilize display readings (If display stability appears to be a problem and the sacrifice in display resolution is unacceptable, program higher levels of digital filtering or increase the level of process dampening). Rounding increments of 10, 20, 50, and 100 may also be used to add "dummy zeroes" to the scaled readings, as desired.

1
2
5
10
20
50
100

The rounding increment is for the controller's display only and does not affect (degrade) the control accuracy of the unit.

Input Signal Filter and Display Update Rate (FLtr)

Select the relative degree of input signal filtering and display update rate. The filter is an adaptive digital filter that discriminates between measurement noise and actual process changes. Therefore, the influence on step response time is minimal. If the signal is varying too greatly due to measurement noise, increase the filter value. Additionally, with large derivative times, control action may be too unstable for accurate control. Increase the filter value. Conversely, if the fastest controller response is desired, decrease the filter value.

The Auto-tune procedure sets the filter value appropriate to the process characteristics. Also see *Output Power Dampening parameter (OPdP)*, page 25, for filtering the output.

Fltr- 0 to 4

0 = least input filtering

3 = most input filtering

4 = most input filtering and slower (2/sec) display update rate
(outputs update at 10/sec rate)

Scaling Points

Prior to installing and operating the controller, it may be necessary to change the scaling to suit the display units particular to the application. Although the unit has been programmed at the factory, the scaling will generally have to be changed.

The controller is unique in that two different scaling methods are available. The operator may choose the method that yields the easier or more accurate calibration. The two scaling procedures are similar in that the operator keys in or applies a signal value that corresponds to those scaling points. The location of the scaling points should be near the process end limits, for the best possible accuracy.

Once these values are programmed (coordinates on a graph), the indicator calculates the slope and intercept of the signal/display graph automatically. No span/zero interaction occurs, making scaling a one-pass exercise.

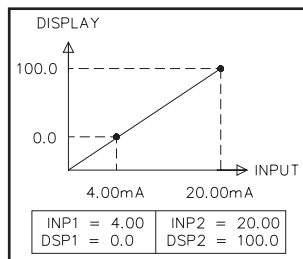

Figure 12, Scaling Points

Before programming the indicator, it is advised to organize all the data for the programming steps to avoid possible confusion.

To scale the indicator, two signal values and two display values that correspond to the signal values must be known. These four values are used to complete the scaling operation. An example is listed below:

Scaling Point #1 **Scaling Point #2**
0.0% @ 4.00 mA & 100.0% @ 20.00 mA

Reverse acting indication can be accomplished by either reversing the two signal points or the display value points, but not both. If both are reversed, then forward (normal) acting indication will occur. In either case, do not reverse the input wires to correct the action.

Display Values (dSP1 & dSP2)

Key-in the display value for scaling point one and scaling point two.

dSP1 -999 to 9999 (Ex. 0.0%)

dSP2 -999 to 9999 (Ex. 100.0%)

Signal Input Values (INP1 & INP2)

The signal input value can either be keyed in via the front panel buttons or an input signal can be applied to the appropriate signal input terminals. When entering the signal input parameter, the unit is in the key-in mode.

Key-in Method

Key-in the signal value for scaling point one and scaling point two.

INP1 -999 to 9999 (Ex. 0.00 VDC or 4.00 mA DC)

INP2 -999 to 9999 (Ex. 10.00 VDC or 20.00 mA DC)

Signal Input Method

To change to the apply signal method press the DSP button. Front panel annunciators % PW and DEV will flash, and the display indicates the signal value applied to the input terminals. The unit can be toggled to the key-in method by pressing the DSP button again.

Signal Range	Display Range
4.00 to 20.0 mA DC	0.00 to 20.00
0.00 to 10.00 VDC	0.00 to 10.00

When the desired value is indicated on the display, press the PAR button to store the value and advance to the next parameter.

Setpoint Limit Values (SPLO & SPHI)

The controller has programmable high and low setpoint limit values to restrict the setting range of the setpoint. Set the limit values so that the setpoint value cannot be set outside the safe operating area of the process. On models equipped with Second Analog Input, configured as a Remote Setpoint, the Remote Setpoint reading is also restricted to these limits.

SPLO - -999 to 9999

SPHI - -999 to 9999

Setpoint Ramp Rate (SPrP)

The setpoint can be programmed to ramp independent of the controller's decimal point position and rounding increment. The setpoint ramp rate can reduce sudden shock to the process, reduce overshoot on start-up or setpoint changes, or ramp the process at a controlled rate.

SPrP - 0.1 to 999.9 units/minute

A ramp value of zero disables setpoint ramping. If the optional user input is programmed for setpoint ramp, it affects the enabling and disabling of setpoint ramping (See *User Input*, page 23). Setpoint ramping is initiated on power-up or when the setpoint value is changed and is indicated by a decimal point flashing in the far right corner of the main display.

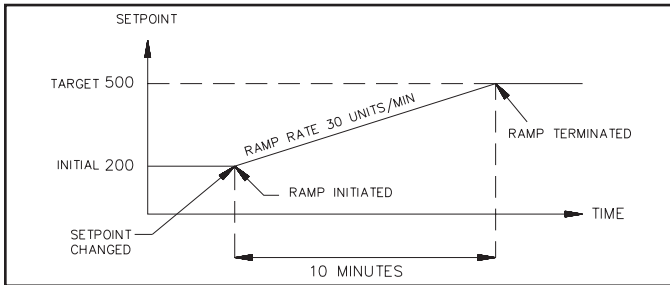

Figure 13, Setpoint Ramp Rate

Once the ramping setpoint reaches the target setpoint, the setpoint ramp rate disengages until the setpoint is changed again. If the ramp value is changed during ramping, the new ramp rate takes effect. If the setpoint is

ramping prior to invoking Auto-Tune, the ramping is suspended during Auto-Tune and then resumed afterward using the current display as a starting value. Deviation and band alarms are relative to the target setpoint, not the ramping setpoint. If the analog output is programmed to transmit the setpoint value, the instantaneous ramping setpoint value is transmitted.

Note: Depending on the ramp rate relative to the process dynamics, the actual scaled process value may not track the ramping setpoint value.

On models equipped with Second Analog Input, configured as Remote Setpoint, this parameter may be used to establish a maximum rate of change of the Remote Setpoint reading. If the controller or transmitter that supplies the Remote Setpoint reading is swinging too wildly, or changing too fast, resulting in control problems, the ramp rate can be used to reduce the rate of change of the Remote Setpoint reading. When ramping in Remote Setpoint operation, the flashing decimal point is suppressed. The units of ramping for Remote Setpoint operation are 0.1 to 999.9 LSD/minute.

User Input (InPt)

The user input may be programmed to perform a variety of controller functions. The input must be in its active state for 100 msec minimum to perform the function. The unit executes all functions in 100 msec, except the print request function that requires 110 to 200 msec for a response. A function is performed when the User Input, (Terminal 7) is used in conjunction with common (Terminal 10).

Note: Do not tie the commons of multiple units to a single switch. Use either a multiple pole switch for ganged operation or a single switch for each unit.

Below is a list of the available functions.

PLOC - Program Lock. A low level enables the program disable function which places the unit in the Protected Parameter Mode.

Note: Front panel disable is possible without using this program lock function, see Front Panel Program Disable, page 19.

ILOC - Integral Action Lock. A low level disables the integral action of the PID computation. A high level resumes the integral action.

trnF - Auto/Manual Transfer. A negative transition places the unit in the manual (user) mode and a positive transition places the unit in the automatic operating mode. The output is “bumpless” when transferring to either operating mode.

User Input (InPt) (Cont'd)

SPrP - Setpoint Ramp. A low level terminates setpoint ramping and the controller operates at the target setpoint. Terminating setpoint ramping is the same as setting the ramp rate to zero (SPrP = 0.0). A high level enables the programmed setpoint ramp rate.

ALrS - Alarm Reset. If the alarm option is installed, a low level resets the alarm(s) to their inactive state as long as the user input is low.

Prnt - Print Request. A low level transmits the print options selected in the serial communications module (6-SC). If the user input is held low, after the printing is complete a second print request is issued.

SPSL - Select Local or Remote Setpoint. On models equipped with Second Analog Input, configured as Remote Setpoint, a negative transition engages Remote Setpoint operation and a positive transition engages Local Setpoint operation. Select the controller output response to the Local/Remote transfer operation (bumpless, tracking, etc) by the setpoint transfer parameter (SPtr).

OUTPUT MODULE (2-OP)

The controller has parameters that affect how the main control output (OP1) responds to process changes and signal overdrive actions.

Time Proportioning Cycle Time (CYCt)

The selection of cycle time depends on the time constant of the process and the type of output module used.

CYCt - 0 to 250 seconds

For best control, a cycle time equal to 1/10 of the process time constant, or less is recommended; longer cycle times could degrade process control, and shorter cycle times provide little benefit at the expense of shortened relay life. When using a Triac module or a Logic/SSR drive output module with the SSR Power Unit, a relatively short cycle time may be selected.

A setting of zero keeps the main control output and front panel indicator off. Therefore, if using the analog output for control, the main output and indicator can be disabled. This parameter is skipped for Valve Positioner models.

Output Control Action (OPAC)

The main control output (OP1) channel is programmable for reverse acting or direct acting. Most control applications use reverse acting (See *ON/OFF Control*, page 62).

OPAC - rEv (Reverse acting)
drct (Direct acting)

If drct (direct acting) is selected, the main output (OP1) is direct acting and the secondary output (OP2) is reverse acting. The secondary output always maintains the opposite setting of the main output.

Note: When using a relay output module, the control action may also be reversed by using the normally closed contacts.

The linear DC analog output, when assigned to output power (OP) for control purposes, tracks the controller output power demand. A direct acting linear output signal can be implemented in two ways:

1. Use "direct" for output control action (OPAC).
2. Interchange the two analog output scaling points ANLO & ANHI (See *Linear DC Analog Output*, page 26).

Output Power Limits (OPLO & OPHI)

Enter the safe output power limits for the process. These parameters may also be used to limit the minimum and maximum controller power due to process disturbances or setpoint changes, to reduce overshoots by limiting the process approach level.

OPLO & OPHI - 0 to 100%

If the secondary output option is installed, the limits range from:

OPLO & OPHI - -100 to 100%

With the secondary output option installed, the Lower Limit can be set to less than 0% to limit maximum secondary output power or set to greater than 0% to limit minimum main control output power. Set the High Limit to less than 0% to limit minimum secondary output power or greater than 0% to limit maximum main control output power. When controlling power in the manual mode, the output power limits do not take effect.

Input Overdrive Preset Power (OPFL)

If an input overdrive signal is detected, the control output(s) default to a preset power output.

OPFL - 0% (OP1 output full “off”) to 100% (OP1 output full “on”)

If the secondary output option is installed, the range is extended from:

OPFL - -100% to +100%

At 0% both outputs are off, at 100% OP1 is on and OP2 is off, and at -100% OP2 is on and OP1 is off. The alarm outputs always have an up-scale drive (+9999), independent of this setting, for an input overdrive signal.

For position mode valve controllers, the valve is positioned according to the setting of this parameter.

For velocity mode valve controllers, the following actions occur:

Velocity mode: OPFL = 0%, valve CLOSE output activates

OPFL = 100%, valve OPEN output activates

OPFL = any other setting, both valve outputs disable

Output Power Dampening (OPdP)

The output power calculated by the PID controller can be dampened (filtered) to reduce the controller output activity. Those processes with high gain and/or derivative times or those processes with a relatively high noise content can benefit from the dampening action.

OPdP - 0 to 250 seconds

The dampening parameter is expressed as a time constant in seconds. Increasing the value increases the dampening or filtering effect. A value of zero disables output power dampening. The amount of dampening to be used depends primarily on the response time of the process and the amount of final actuator activity desired. Generally, dampening times in the range of 1/20 to 1/50 of the controller’s integral time (or process time constant) prove to be effective. Dampening times longer than these may cause controller instability due to the added lag effect of too much filtering.

In the case where a relatively high dampening time is desired, the controller’s proportional band may be increased to restore an adequate stability margin. The Auto-tune procedure of the controller sets the dampening value appropriate to the characteristics of the process.

ON/OFF Control Hysteresis Band (CHYS)

The controller can be placed in the ON/OFF control mode by setting the proportional band to 0.0%. The control hysteresis value affects only the main control output (OP1).

CHYS - 1 to 250 units

The hysteresis band should be set to a minimum value to eliminate output chatter at the setpoint. Set the hysteresis band to a sufficient level prior to invoking Auto-Tune. Internal cascade controllers, secondary loop, have a fixed hysteresis of 1.5% of scaled range.

Auto-Tune Dampening Code (tcod)

Prior to invoking Auto-Tune, the dampening code should be set to achieve the desired dampening level under PID control. After Auto-tune is complete, changes to "tcod" parameter have no effect until Auto-tune is re-started. When set to 0, this yields the fastest process response with possible overshoot. A setting of 4 yields the slowest response with the least amount of overshoot. Dampening codes of 0 or 1 are recommended for most processes.

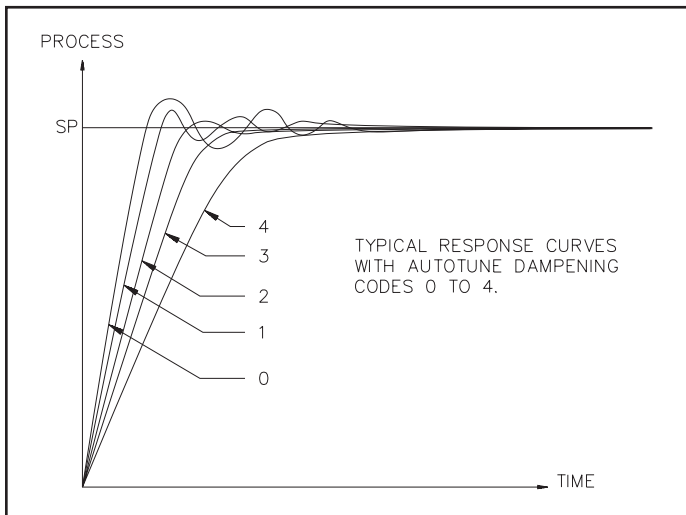

Figure 14, Dampening Code

Linear DC Analog Output (ANAS, ANLO, ANHI, ANdb, ANUt) (Optional)

The Linear DC output can be programmed to transmit one of the following controller parameters:

ASSIGN DC OUTPUT (ANAS):

- OP – Percent output power
- INP – Scaled input process value
- dEV – Process setpoint deviation
- SP – Process setpoint value
- dE-2 – Process deviation of secondary loop (Internal Cascade only)
- SP-2 – Process setpoint of secondary loop (Internal Cascade only)

With high and low digital scaling points, the range of the Linear DC output can be set independent of the controller's range. This allows interfacing directly with chart recorders, remote indicators, slave controllers, or linear power control units.

ANLO (4 mA or 0 VDC) – -999 to 9999

ANHI (20 mA or 10 VDC) – -999 to 9999

Linear DC output deadband (ANdb) and linear DC output update time (ANUt) parameters are additional parameters used for control purposes (ANAS=OP). The deadband parameter requires that the output power, in percent, must change more than the deadband amount in order for the output to update. A value of 0.0 disables the deadband action. The linear output update time updates the output at the time interval specified. A value of 0 seconds updates the output at the controller's scan rate (10/sec). In the manual mode of operation both parameters are overridden. The front panel indicator OPI and main output can be disabled by setting the time proportioning cycle time equal to zero (CYCt = 0).

Note: Valve Position controllers disable the "OPEN" and "CLOSE" outputs when the linear DC output is assigned to output power. In this case, the slidewire feedback signal may be used to verify valve position.

ANdb – 0.0 to 25.0%

ANUt – 0 to 250 seconds

For setpoint transmission, (external cascade control used with another controller), the controller transmits the instantaneous ramping setpoint, not the target value, when the controller is ramping the setpoint. For models with Remote Setpoint, the linear output transmits the active setpoint (local or remote).

Example: Chart Record Process Display Value (0 to 10 VDC):

The process range is 300-700. Programming 300 for ANLO (0 VDC value) and 700 for ANHI (10 VDC value) yields full scale deflection for a chart recorder (0 to 10 VDC). The 0 to 10 VDC output is assigned to transmit the input reading (ANAS = INP).

Example: Linear Control Output (4 to 20 mA):

A linear DC input power control unit is used for process control. An output control deadband of $\pm 2.0\%$ and an output update time of 10 seconds is desired. The following set-up values illustrate the configuration:

ANAS = OP
ANLO = 0.0%
ANHI = 100.0%
ANdb = 2.0%
ANUt = 10 seconds

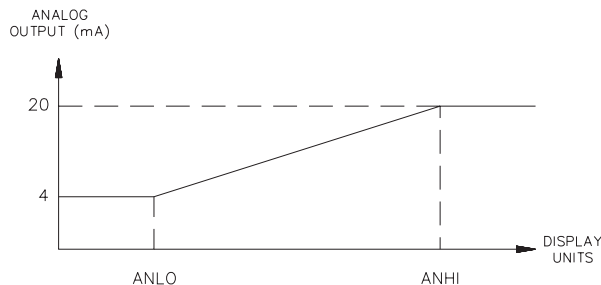

Figure 15, Linear DC Output

LOCKOUTS MODULE (3-LC)

The controller can be programmed to limit operator access to various parameters, control modes, and display contents. The configuration of the lockouts is grouped into three sections: Lower Display Lockouts, Protected Mode Lockouts and Hidden Mode Lockouts.

Lower Display Lockouts (SP, OP, IN-2, dEv, bdSP)

The contents of the secondary display can be changed in the normal display mode by successively pressing the DSP button. This action scrolls through the possible display parameters, when enabled.

The parameters can be set for one of the following:

- LOC (Lockout) – Prevents the parameter from appearing in the secondary display.
- rEd (Read only) – Parameter appears, but cannot be modified.
- Ent (Entry) – Parameter appears and can be modified.

The lower display content possibilities are:

- SP – Setpoint Value
- OP* – % Output Power
- IN-2* – Second analog input (Remote setpoint)
- dEv* – Setpoint Deviation
- bdSP – Blank Display

If all parameters are set to lock “LOC”, the display remains on the last parameter that was viewed.

**Note: These parameters are model specific and may not appear in the programming sequence.*

Note: If a parameter is active in the lower display and is then subsequently locked out, press “DSP” once in the normal display mode to remove it from the display.

Protected Mode Lockouts (Code, PID, PID2, rtbS & AL)

The protected mode is active when program disable is active. The parameters in the protected mode can be set for one of the following modes:

- LOC (Lockout) – Prevents the parameter from appearing in the protected mode.
- rEd (Read only) – Parameter appears, but cannot be modified.
- Ent (Entry) – Parameter appears and can be modified.

The code number allows access to the unprotected mode. To enter the unprotected mode from the protected mode, the code number entered must match the code number entered here. See *Front Panel Program Disable*, page 19, for a description of the various program access levels.

- Code – 0 to 250
- PID – Permits access to the main PID parameters
- PID2* – Permits access to the secondary PID parameters
- rtbS* – Permits access to Remote Setpoint ratio and bias parameters
- AL* – Permits access to the alarm value(s).

Hidden Mode Lockouts (ALrS, trnF, tUNE and SPsL)

The hidden mode is accessible from the normal display mode by pressing and holding the PAR button for three seconds. The parameters can be set for:

- LOC (Lockout) – Prevents the parameter from appearing in the hidden mode.
- ENbL (Enable) – Allows operator to perform the selected hidden mode function.

The functions available in the hidden mode are accessible independent of the status of program disable.

- ALrS* – Reset (override) the alarm output(s).
- SPsL* – Select Local or Remote Setpoint operation.
- trnF – Select Automatic or Manual operation.
- tUNE – Invoke or cancel Auto-Tune.

* Note: These parameters are model specific and may not appear in the programming sequence.

ALARM MODULE (4-AL) (OPTIONAL)

The controller may be optionally fitted with the dual alarm option (AL1 and AL2). Some models are equipped only with a single alarm (AL1). One of three types of output modules (Relay, Logic/SSR Drive or Triac) must be ordered separately and installed into the appropriate alarm channel socket.

The output modules may be replaced or interchanged (with appropriate wiring considerations) at any time without re-programming the controller. The alarm values can be accessed in configuration module (4-AL), the unprotected mode, and in the protected mode, if not locked.

A front panel annunciator illuminates to indicate that the alarm output is on (AL1 for alarm 1 and AL2 for alarm 2).

Note: When deviation low-acting with positive alarm value (d-LO), deviation high-acting with negative value (d-HI), or Band inside-acting (b-IN) is selected for the alarm action, the indicator is "OFF" when the alarm output is "ON". These alarm modes latch the outputs when the output is "ON", when selected for latched operation.

Caution: In applications where equipment or material damage, or risk to personnel, due to controller malfunction could occur, an independent and redundant process limit indicator with alarm outputs is strongly recommended. Red Lion Controls offers various units (such as an IMP, IMD1 or IMD2) that may be used for this purpose. The indicators should have input and AC power feeds independent from the other equipment.

Alarm Action (Act1, Act2)

The alarm(s) may be independently configured for one of the following modes:

- | | | |
|-----------------------|---------|---|
| Absolute High Acting | (A-Hi) | } Relative to Setpoint
(Local or Remote) |
| Absolute Low Acting | (A-LO) | |
| Deviation High Acting | (d-Hi) | |
| Deviation Low Acting | (d-LO) | |
| Band Inside Acting | (b-in) | |
| Band Outside Acting | (b-Out) | |

Second Analog Input Alarm

On models equipped with the Second Analog Input, the alarm(s) may be configured to monitor the second input reading in addition to the main input. Refer to the corresponding alarm operation figures for operation modes.

Note that deviation and band alarm modes are only valid for Internal Cascade operation.

Absolute High Acting -2	(A2HI)	} Relative to SP-2, Second Input (Internal Cascade)
Absolute Low Acting -2	(A2LO)	
Deviation High Acting -2	(d2HI)	
Deviation Low Acting -2	(d2LO)	
Band Inside Acting -2	(b2IN)	
Band Outside Acting -2	(b2Ot)	

Valve Fail Alarm (VFAL)

On models equipped with Valve Positioner (Position mode control only), Alarm #1 may be configured as a valve fail alarm (Act1 = valv). This alarm mode is useful to provide early detection of valve failure before significant process errors occur. In this mode, the usual alarm function is disabled.

The alarm triggers under the two following conditions:

1. The valve slidewire feedback position does not match the controller output power (within the valve position deadband) after the valve fail time has expired. The alarm indicates that the valve cannot be properly positioned due to a malfunction of the valve or valve positioner.
2. The slidewire feedback signal is broken or out of range. In this case, the valve position controller cannot position the valve.

Message display alarms “valv” and “slid” appear when conditions 1 and 2 occur, respectively, whether or not the alarm is configured as a valve fail alarm. This alarm mode also applies to linear DC output used for valve positioning. In this case, a slidewire signal must be supplied to the controller for valve fail detection. To silence a triggered Valve Fail alarm, see *Valve Fail Time Alarm (VFAL)* parameter, page 38.

The alarm action figures describe the status of the alarm output and the front panel indicator for various over/under process conditions. (See *Output Module “OUTPUT ON” State Table*, page 6, for definitions, under installing output modules section.) The alarm output wave form is shown with the output in the automatic reset mode.

Note: Select the alarm action with care. In some configurations, the front panel indicator (LED) might be “OFF” while the output is “ON”.

Alarm Action Figures

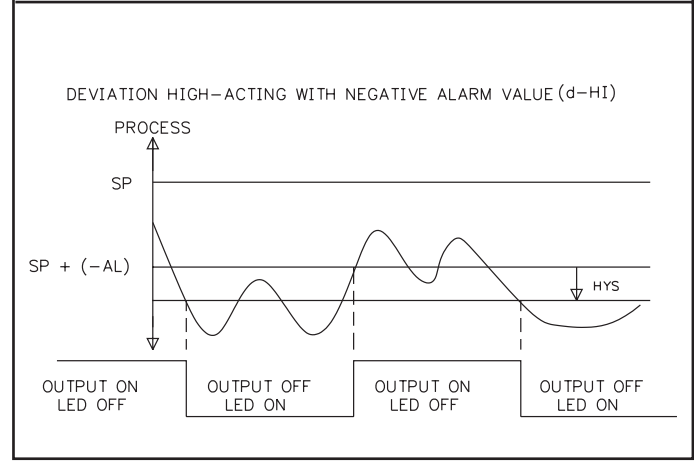
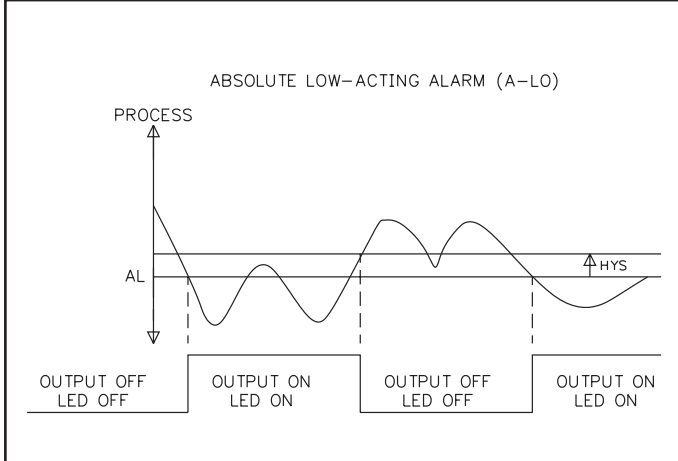
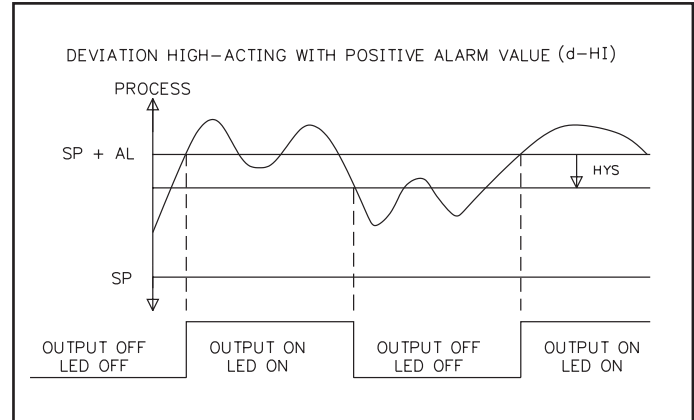
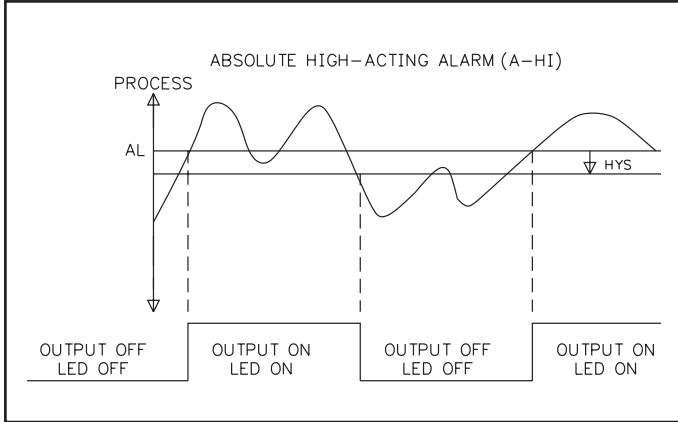

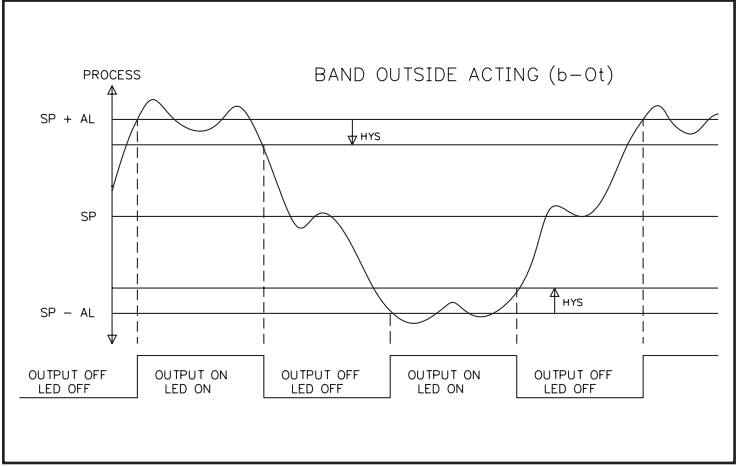
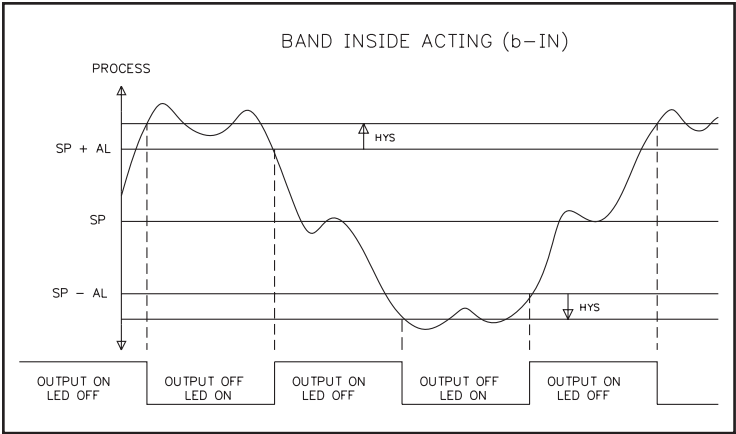
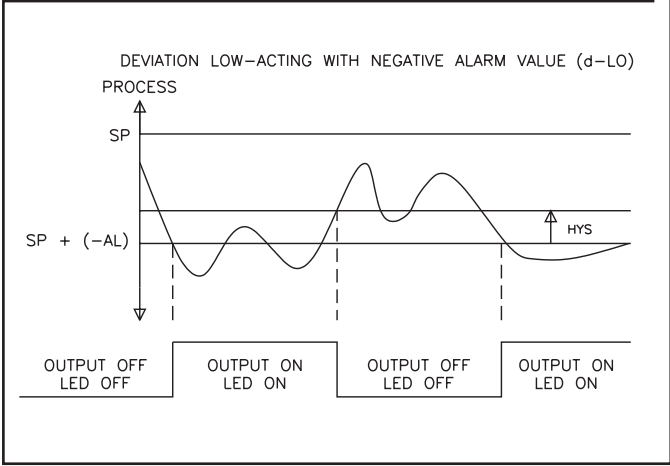
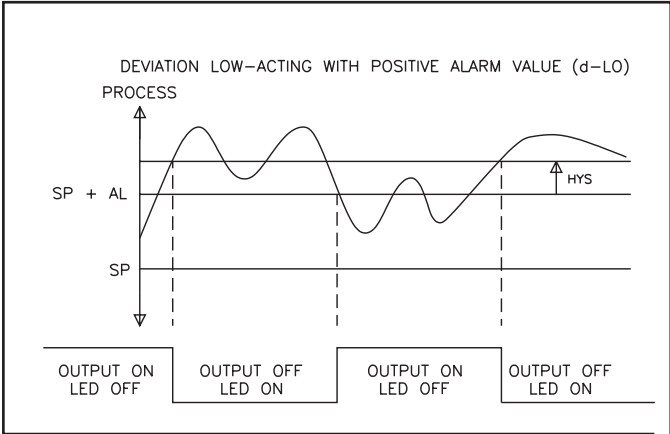

Alarm Reset (rSt1, rSt2)

Each alarm reset action may be independently configured.

LAtC - Latching

Auto - Automatic

Latched alarms require operator acknowledgment to reset the alarm condition. The front panel buttons can be used to reset an alarm when the controller is in the hidden mode (see *Hidden Function Mode*, page 20). An Alarm condition may also be reset via the RS485 serial interface or by the user input. Automatic (Auto) reset alarms are reset by the controller when the alarm condition clears. Figure 16, Alarm Reset Sequence, depicts the reset types.

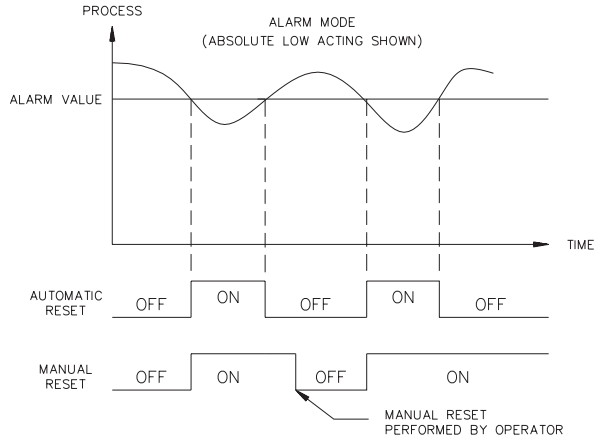

Figure 16, Alarm Reset Sequence

Alarm Standby Delay (Stb1, Stb2)

The alarm(s) may be independently configured to exhibit a power-on, standby delay which suppresses the alarm output from turning “ON” until the process first stabilizes outside the alarm region. After this condition is satisfied, the alarm standby delay is canceled and the alarm triggers normally, until the next controller power-on. Figure 17, Alarm Standby Delay Sequence depicts a typical operation sequence.

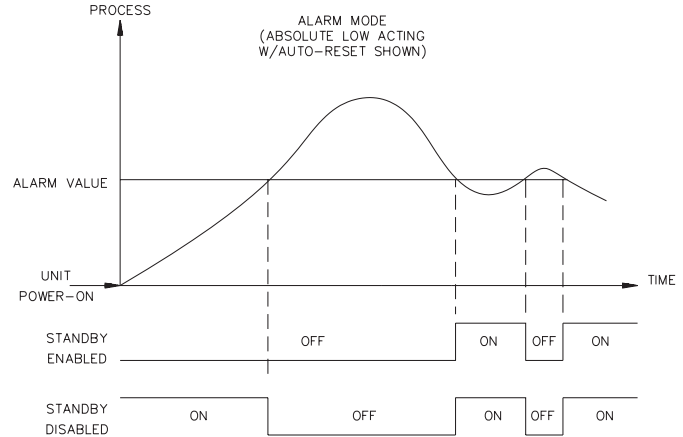

Figure 17, Alarm Standby Delay Sequence

Alarm Value (AL-1, AL-2)

The alarm values are either absolute (absolute alarms) or relative to the setpoint value (deviation and band alarms). An absolute alarm value is the value that is entered. A relative alarm value is offset from the process setpoint value by the amount entered and tracks the setpoint value as it is changed.

AL-1 and AL-2 - -999 to 9999

If the alarm action is set as a Band Alarm, then only a positive value can be entered.

AL-1 and AL-2 - 0 to 9999

Alarm Hysteresis (AHYS)

The alarm(s) values have a programmable hysteresis band to prevent alarm output chatter near the alarm trigger setpoint. The hysteresis value should be set to eliminate this effect. A value of 2 to 5 is usually sufficient for most applications. A single alarm hysteresis value applies to both alarms. See the *Alarm Action Figures*, page 30, for the effect of hysteresis on the various alarm types.

AHYS - 1 to 250

SECONDARY OUTPUT MODULE (5-02) (OPTIONAL)

The optional secondary output (OP2) operates as an independent output for systems that require a second output. One of the three types of output modules (Relay, Logic/SSR Drive or Triac) must be ordered separately and installed into the OP2 channel socket. The output modules may be replaced or interchanged (with appropriate wiring considerations) at any time without re-programming the controller.

The front panel indicator OP2 illuminates when the secondary output is on. (See *Output Module "OUTPUT ON" State Table*, page 6, for definition). Secondary output power is defined as ranging from -100% (full on) to 0% (off, unless a deadband overlap is used).

Time Proportioning Cycle Time (CYC2)

A value of 0 turns off the secondary output, independent of power demand.

CYC2 - 0 to 250 seconds

Relative Gain (GAN2)

This parameter defines the gain of the secondary band relative to the main output band. A value of 0.0 places the secondary output into ON/OFF control mode with the parameter (db-2) becoming the secondary output hysteresis. This may be done independent of the main output control mode (PID or ON/OFF). Relative gain is generally set to balance the effects of OP2 to that of OP1 for best control.

GAN2 - 0.0 to 10.0

Overlap/Deadband (db-2)

This parameter defines the area in which both the main control output and secondary output are active (negative value) or the deadband area between the bands (positive value). If an overlap is specified, the displayed percent output power is the sum of the main power (OP1) and the secondary power (OP2).

db-2 - -999 to 9999

If relative gain is zero, the secondary output operates in the ON/OFF mode, with this parameter becoming the secondary output hysteresis (positive value only). The Operation Figures illustrate the effects of different deadbands.

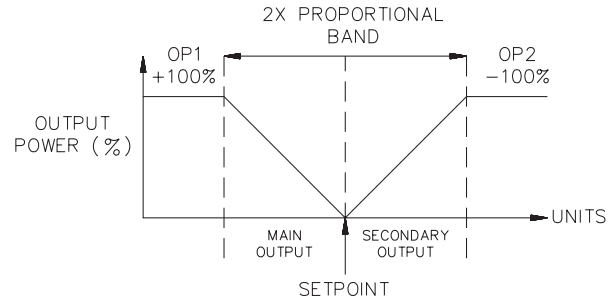

Figure 18, Operation (db=0)

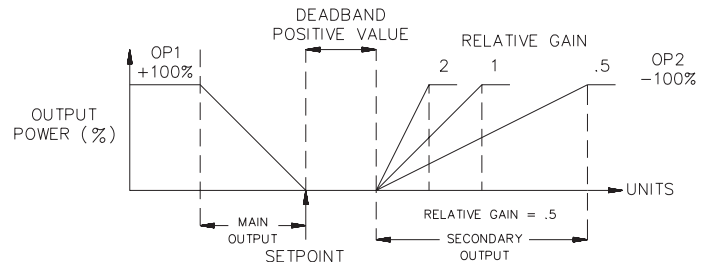

Figure 19, Operation (db>0)

Overlap/Deadband (db-2) (Cont'd)

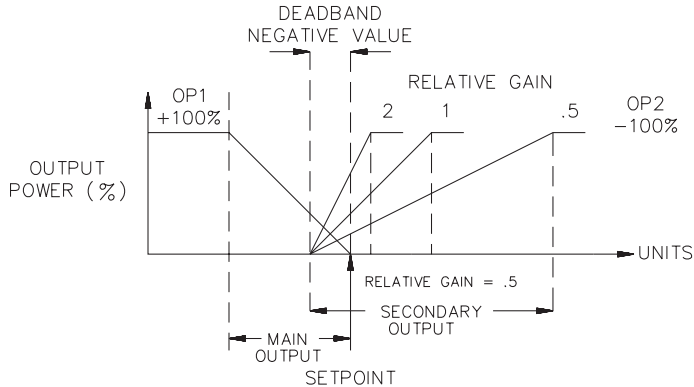

Figure 20, Operation (db<0>)

In practice with the secondary output, observe the controlled process characteristics and if the process remains above setpoint with a sluggish return, increase the relative gain. Similarly, if the process drops too sharply with an overall saw-tooth pattern, decrease the relative gain. Alter the deadband/overlap until a smooth response in the controlled process is observed during band transition.

SERIAL COMMUNICATIONS MODULE (6-SC) (OPTIONAL)

When communicating with a PCU unit via the serial port, the data formats of both units must be identical. A print operation occurs when the user input, programmed for the print request function is activated, when a "P" command is sent via the serial communications port, or after the time expires for the automatic print rate, if enabled. Serial communication is covered in detail in *RS485 Serial Communications Interface*, page 47.

Baud Rate (bAud)

The available baud rates are:
300, 600, 1200, 2400, 4800, or 9600

Parity Bit (PArb)

Parity can be odd, even, or no parity.

Address Number (Addr)

Multiple units connected on the same RS485 interface line must each have a different address number. A value of 0 does not require the address specifier command, when communicating with the PCU. The address numbers range from 0 to 99.

Abbreviated or Full Transmission (Abrv)

When transmitting data, the PCU can be programmed to suppress the address number, mnemonics, units, and some spaces by selecting YES. An example of abbreviated and full transmission are shown below:

```
NO - 6 SET 123.8F<CR><LF> Full Transmission
YES - 123.8<CR><LF> Abbreviated Transmission
```

Print Rate (PrAt)

The PCU can be programmed to automatically transmit the selected print options at the programmed print rate. Selecting 0 (zero) disables the automatic print rate feature.

PrAt - 0 to 9999 seconds

Print Options (PoPt)

Selecting YES for the print options allows the operator to scroll through the available options using the PAR button. The up and down arrow keys toggle between “yes” and “no” with “yes” enabling the option to be printed when a print function occurs.

- INP - Print Input Process Value
- SEt - Print Setpoint Value
- OPr - Print % Output Power Value
- Pbd - Print % Proportional Band Value
- INt - Print Integral Time Value
- dEr - Print Derivative Time Value
- AL1 - Print Alarm 1 Value
- AL2 - Print Alarm 2 Value
- dEv - Print Deviation From Setpoint Value
- OFp - Print % Output Power Offset Value
- r-P - Print Setpoint Ramp Rate Value
- Crg - Print Relative Gain Value
- Cdb - Print Deadband Value
- OSt - Print Output Status
- rAt - Print Remote Setpoint Ratio
- bIA - Print Remote Setpoint Bias
- rSP - Print Remote Setpoint Reading
- IN2 - Print Second Input Reading
- Pb2 - Print Proportional Band #2
- It2 - Print Integral Time #2
- dt2 - Print Derivative Time #2
- SP2 - Print Internal Cascade Directed Setpoint

SECOND ANALOG INPUT MODULE (7-2N) (OPTIONAL)

The Second Analog Input can be configured as a Remote Setpoint Input or as a Secondary Input for Internal Cascade control. As a Remote Setpoint, the controller can operate as an External Cascade controller, Setpoint Slave controller and as a Ratio controller. See *Cascade Control*, page 56, for an overview of cascade control.

Operation mode (OPeR)

The Second Analog Input must be configured for either Remote Setpoint Operation or Internal Cascade Operation (single controller cascade).

- rSP - Remote Setpoint
- CSCd - Internal Cascade

Square Root Linearization (root)

In some cases it may be necessary to linearize the Second Analog input by use of the square root function.

Selection of ‘yES’ results in the square root linearization of the Second Analog Input(only). Selection of ‘NO’, results in linear scaling. The square root linearization exhibits a 3% low cut point (17% of scaled reading) to eliminate reading jitter at low flow rates. The following example illustrates the scaling of the Second Analog Input with square root linearization.

Example: It is necessary to square root linearize the output of a differential pressure transmitter to indicate and control flow. The defining equation is $F = 278 \sqrt{\Delta p}$, where $\Delta P = 0 - 500$ PSI, transmitted linearly by a 4 - 20 mA transducer. At full flow rate ($\Delta P = 500$ PSI), the flow is 6216 ft³/hr. The following scaling information is used with the controller:

- dPt2 = 0
- root = yES
- dSP1 = 0 Ft³/hr
- INP1 = 4.00 mA
- dSP2 = 6216 Ft³/hr
- INP2 = 20.00 mA

Local/Remote Setpoint Transfer Modes (SPtr)

When switching from/to Local or Remote Setpoint, the response of the controller can be programmed to act in a variety of ways.

These responses apply to changes in setpoint mode from the controller's front panel, User Input or Serial communications. The table summarizes the responses for Setpoint transfer operation:

SPtr parameter	Local to Remote	Remote to Local
nor	– Output may bump.	Output may bump.
Auto	– No output bump. Process error eliminated at rate of integral action.	No output bump. Process error eliminated at rate of integral action.
trAC	– Output may bump.	Local setpoint assumes value of Remote setpoint (tracks). No output bump.

Note: In situations where an output bump may occur, the setpoint ramp function (SPrP) can be used to reduce or eliminate bumping when switching setpoint modes. The setpoint ramp feature ramps the setpoint from the old setpoint mode to the new setpoint mode. After the initial ramp has been completed, the active setpoint (Local or Remote) remains in the setpoint ramp mode.

Secondary Output Power Dampening (OPd2)

The output power of the secondary loop (Internal Cascade) can be dampened (filtered) independent of the primary loop. The secondary output power is the actual output of the controller. The primary output power (setpoint to the secondary) is dampened by the OPdP parameter. The secondary output power is dampened by the OPd2 parameter.

VALVE POSITIONER MODULE (8-VP)

The Valve Positioner controller must be configured to operate in either Position Mode or Velocity Mode. Position Mode requires a slidewire feedback signal from the valve or valve positioner. Velocity Mode does not require a slidewire feedback signal. See *Valve Position Option*, page 54, for an overview of valve position control.

Valve Position 1 And Valve Position 2 (VPS1, VPS2)

The full closed valve position and the full open valve position are represented by parameters VPS1 and VPS2, respectively. These values are expressed as a percentage of the valve open position. They do not represent slidewire resistance. Normally, for position mode control, VPS1 = 0.0% and VPS2 = 100.0%. In some processes, it may be necessary to limit the range over which the controller positions the valve. In such a case, VPS1 defines the minimum open position and VPS2 defines the maximum open position. The controller then scales the valve position values to represent 0 and 100% output power. In this way the valve is confined to work over a smaller portion of its total range.

Setting both parameters to 0.0% engages velocity mode control. Slidewire feedback is not required for velocity mode. Additionally, slightly different controller parameters are required for this mode.

VPS1 & VPS2 – -99.9% to 999.9%

For position mode control, there are several ways to determine the valve position values:

- 1) Position the valve to the closed or open positions (by use of the controller or manually) and have the controller measure and record these positions. To engage this mode, press the DSP button while either VPS1 or VPS2 parameters are called. %PW and DEV annunciators flash to indicate this mode. The valve may then be positioned directly through the use of the front panel UP and DOWN buttons. The UP button causes the valve to move open and the DOWN button causes the valve to move closed. Simultaneously, the controller indicates the slidewire position. After the valve has been moved to the desired position (by use of the button and observing the display), press PAR to record the position. This technique is preferred because it compensates for leadwire resistance errors.

Valve Position 1 And Valve Position 2 (VPS1, VPS2) (Cont'd)

- 2) Use the specifications provided by the valve manufacturer. Divide the closed and open position resistance values by the total slidewire resistance to yield percentage values. Directly key-in the values as a percentage.
- 3) Measure the resistance of the open and closed positions and divide by the total slidewire resistance to yield percentage values. Directly key-in the percentage values.

Valve Update Time (VUdt) (Position And Velocity Mode)

The valve update time is the time interval in which the valve position outputs are updated. The update time may be increased to reduce valve activity. Valve update times up to 1/10 of the integral time (or process time constant) may be used with good results. Longer update times may adversely affect control quality. The update time is variable from 0 to 250 seconds. A value of zero causes the valve position to be updated at the controller's scan rate (10/sec).

Valve Position Deadband (VPdb) (Position Mode)

The difference between the power output and the slidewire valve position must exceed the deadband in order for the controller to update the valve position. Normally, the deadband is set to a minimum to compensate for valve motor overrun and gearing backlash to eliminate hunting. Deadband values that are too large may result in excessive errors. Values that are too small may result in excessive hunting. The Output Power Dampening (OPdP) parameter can also be used to reduce valve activity. Typically set in the range of 1 to 3%.

VPdb - 0.0% to 25.0%

Valve Fail Time Alarm (VFAL) (Position Mode)

The valve fail time is the maximum time allowed in which the slidewire feedback signal must match the output power before an error message appears. If this condition is not met, a valve sentry alarm message appears ("VALV" in display), indicating a failed valve or failed valve positioner. Optionally, an alarm can be configured to provide an output event (see *Alarm Action*, page 28). This feature also applies to valve positioning with linear DC output. The fail time must be set, at a minimum, larger than the Valve Update Time together with the valve motor transit time. A value of zero disables the valve fail feature.

An active valve fail alarm is silenced in these ways:

- 1) Set the valve fail time to 0
- 2) The output power and slidewire signals subsequently agree.
- 3) Cycle power to the controller.

VFAL - 0 to 9999

Valve Motor Open Time And Valve Motor Close Time (VOPt, VCLt) (Velocity mode)

For velocity mode control, the valve motor open transit time (VOPt) and valve motor close transit time (VCLt) must be known. In many cases, these transit times differ from the valve specification. The actual transmit times under load are normally measured for best results. In some cases, the open and close times may be different. The transit time range is 1 to 9999 seconds.

Valve Minimum On Time (VONT)(Velocity Mode)

As a result of the pulsed-type algorithm used in velocity mode control, a minimum on-time pulse threshold is required for proper valve control. The control does not update the outputs until the calculated on-time pulse exceeds this value. Normally, set this value to the minimum on-time of the valve motor. If not given, or otherwise unsuitable, set this value approximately equal to 2.0 to 5.0% of valve open or valve close time. The minimum on-time range is 0.1 to 25.0 seconds.

FACTORY SERVICE OPERATIONS MODULE (9-FS)

The Factory Service Operations are programming functions which are performed on an infrequent basis. They include: controller calibration, and reset programming to factory configuration setting. Given the ramifications of these operations, access to each is protected by an access code number. Entering code 66 restores all parameters to factory settings, the unit indicates the operation after the PAR button is pressed, by displaying "rSEt" in the lower display momentarily. The calibration operations are detailed in *Calibration*, page 78.

REFERENCE TABLES: CONFIGURATION PARAMETER MODULES

Configure Module 1 - Input Parameters (1-IN)

Display	Parameter	Range and Units (Factory Setting Value)	Description/ Comments
tYPE	Input type	VOLt - Voltage Curr - Current (Curr)	
root	Square root linearization	Yes/no (no)	Second Analog Input Models only.
dCpt	Decimal point	0, 0.0, 0.00, or 0.000 (0.0)	If 0.000 is selected, scaling points must be a positive value.
rnd	Rounding increments	1, 2, 5, 10, 50, or 100 (0.1)	Used in conjunction with filtering to stabilize the display reading.
FLtr	Digital filtering for input signal	0 to 4 (1)	Increase number for more filtering effect. 4 = 2/sec display update rate.
dSP1	Scaling point #1 Display Value	-999 to 9999 (0.0)	Normally, key-in display low value.
INP1	Scaling point #1 input signal value key-in method	-999 to 9999 (4.00)	Normally, key-in input low value. Press DSP button to select signal input method.
	Signal input method 4 to 20 mA 0-10 VDC	0.00 to 20.00 0.00 to 10.00	Normally, apply input low value.
dSP2	Scaling point #2 display value	-999 to 9999 (100.0)	Normally, key-in display high value.

Display	Parameter	Range and Units (Factory Setting Value)	Description/ Comments
INP2	Scaling point #2 input signal value key-in method	-999 to 9999 (20.00)	Normally, key-in input high value. Press DSP button to select signal input method.
	Signal input method 4 to 20 mA 0-10 VDC	0.00 to 20.00 0.00 to 10.00	Normally, apply input high value.
SPLO	Lower limit setpoint range	-999 to 9999 (0.0)	Set low limit below high limit.
SPHI	Upper limit setpoint range	-999 to 9999 (999.9)	Set high limit above low limit.
SPrP	Setpoint ramp rate	0.0 to 999.9 units/minute (0.0)	0.0 is off (no ramping) This parameter also ramps Remote Setpoint.
InPt	User input	PLOC - Program disable ILOC - Integral action on/off trnf - auto/manual select SPrP - Setpoint ramp rate on/off ALrS - Reset alarm output(s) Prnt - print request SPSL - Remote/Local Setpoint select (PLOC)	Available on all second input (MVP and ANA) models and on models with RS485.

Configure Module 2 - Output Parameters (2-OP)

Display	Parameter	Range and Units (Factory Setting Value)	Description/ Comments
CYct	Cycle time	0 to 250 seconds (2)	0 turns OP1 off. This parameter does not appear if Valve Positioner option is installed.
OPAC	Control Action	drct rEv (rev)	For both PID & ON/OFF control.
OPLO	Output power lower limit range	0% to 100%, OP1 (0)	Set OPLO < OPHI
		-100% to 100%, OP1 & OP2 (-100)	If secondary output is installed.
OPHI	Output power upper limit range	0% to 100%, OP1 (100)	Set OPHI > OPLO
		-100% to 100%OP1 & OP2 (100)	If secondary output is installed.
OPFL	Input overdrive power preset	0% to 100%, OP1	Set to a value to safely control the process in the event of input overdrive condition.
		-100% to 100%, OP1 & OP2 (0)	
OPdP	Output power dampening (filtering) time	0 to 250 seconds (3)	0 = off (no dampening) Set in range of $\%_0$ to $\%_0$ of integral time.
CHYS	ON/OFF control hysteresis	1 to 250 (1.0)	Hysteresis for OP1.
tcod	Auto-tune dampening mode	0 to 4 (0)	0 = fastest response 4 = slowest response

Display	Parameter	Range and Units (Factory Setting Value)	Description/ Comments
ANAS	Linear DC output assignment	OP -% output power INP - scaled display value SP - setpoint value dEv - deviation dE-2 - Internal Cascade Secondary deviation SP-2 - Internal Cascade, Directed Setpoint (OP)	This parameter appears if analog option is installed.
ANLO	Linear DC output low scaling value	-999 to 9999 (0.0)	Units depend on ANAS selection. This parameter appears if analog option is installed.
ANHI	Linear DC output high scaling value	-999 to 9999 (100.0)	Units depend on ANAS selection. This parameter appears if analog option is installed.
ANdb	Linear DC output deadband	0.0 to 25.0% (0.0)	Only used when ANAS=OP. 0.0%= no deadband
ANUt	Linear DC update time	0 to 250 seconds (0)	Only used when ANAS=OP. 0 seconds updates output at a rate of 10/sec.

Configure Module 3 - Lockout Parameters (3-LC)

Display	Parameter	Range and Units (Factory Setting Value)	Description/Comments
SP	Setpoint access	LOC - lockout rEd - read only Ent - enter (Ent)	Determines access to process setpoint.
OP	Output power access	LOC - lockout rEd - read only Ent - enter (Ent)	Determines direct access to output power. %PW indicator illuminates when parameter is selected in display.
dEv	Deviation	LOC - lockout rEd - read only (rEd)	Determines display of deviation. DEV indicator illuminates when parameter is selected in display.
IN-2	Second Analog input	LOC - lockout rEd - read only (rEd)	Determines display of Second Analog input (Remote Setpoint) (SEC) illuminates)
bdSP	Blank display	LOC - lockout rEd - read only (rEd)	Blanks secondary display.
Code	Access code	0 to 250 (0)	Refer to front panel disable section for access levels.
PId	PID values enable	LOC - lockout rEd - read only Ent - enter (LOC)	Protected mode lockout.
PId2	Secondary PID values enable	LOC - lockout rEd - read only Ent - enter (LOC)	Protected mode lockout. Cascade only.

Display	Parameter	Range and Units (Factory Setting Value)	Description/Comments
rtbS	Remote Setpoint Ratio & Bias	LOC - lockout rEd - read only Ent - enter (LOC)	Remote Setpoint Ratio and Bias values enable
AL	Alarm values enable	LOC - lockout rEd - read only Ent - enter (LOC)	Protected mode lockout
ALrS	Reset alarms enable	LOC - lockout ENBL - enable (LOC)	Hidden mode lockout
SPSL	Remote/Local setpoint select enable	LOC - lockout ENBL - enable (LOC)	Hidden mode lockout
trnF	Automatic/Manual (user) mode select enable	LOC - lockout ENBL - enable (LOC)	Hidden mode lockout
tUNE	Auto-tune enable	LOC - lockout ENBL - enable (LOC)	Hidden mode lockout

Configure Module 4 - Alarms (4-AL)

Unit returns to configuration access point if alarm(s) are not installed.

Display	Parameter	Range and Units (Factory Setting Value)	Description/ Comments
Act1	Alarm 1 operation mode	A-HI - absolute high A-LO - absolute low d-HI - deviation high d-LO - deviation low b-IN - band inside b-ot - band outside Valv - valve fail alarm A2HI - absolute high, second input A2LO - absolute low, second input d2HI - deviation high, second input, cascade d2LO - deviation low, second input, cascade b2IN - band in, second input, cascade b2Ot - band out, second input, cascade (A-HI)	If changed, check alarm values.
rSt1	Alarm 1 reset mode	Auto - automatic LAtc - manual reset (Auto)	Manual reset via hidden mode
Stb1	Alarm 1 standby function (delay)	yes/no (no)	Power-up standby delay.
AL-1	Alarm 1 value	-999 to 9999 (0.0)	If band alarm action, then only a positive value can be entered.

Display	Parameter	Range and Units (Factory Setting Value)	Description/ Comments
Act2	Alarm 2 operation mode	A-HI - absolute high A-LO - absolute low d-HI - deviation high d-LO - deviation low b-IN - band inside b-ot - band outside A2HI - absolute high, second input A2LO - absolute low, second input d2HI - deviation high, second input, cascade d2LO - deviation low, second input, cascade b2IN - band in, second input, cascade b2Ot - band out, second input, cascade (A-HI)	If changed, check alarm values.
rSt2	Alarm 2 reset mode	Auto - automatic LAtc - manual reset (Auto)	Manual reset via hidden mode.
Stb2	Alarm 2 standby function (delay)	yes/no (no)	Power-up standby delay.
AL-2	Alarm 2 value	-999 to 9999 (0.0)	If band alarm action, then only a positive value can be entered.
AHYS	Alarm Hysteresis value	1 to 250 (0.1)	Applies to both alarms. Set to eliminate chatter.

Configure Module 5 - Secondary Output Parameters (5-O2)

Unit returns to configuration access point if secondary output option is not installed.

Display	Parameter	Range and Units (Factory Setting Value)	Description/ Comments
CYC2	Secondary output cycle time	0 to 250 sec (2)	0 turns OP2 off.
GAN2	Relative gain	0.0 to 10.0 (1.0)	0.0 places secondary output into ON/OFF control mode and db-2 becomes hysteresis value.
db-2	Overlap-deadband	-999 to 9999 (0.0)	Positive value is deadband. Negative value is overlap. If GAN2 = 0, this parameter is OP2 ON/OFF control hysteresis.

Configure Module 6 - Serial Communications (6-SC)

Unit returns to configuration access point if RS485 serial option is not installed.

Display	Parameter	Range and Units (Factory Setting Value)	Description/ Comments
bAUd	Baud rate	300 to 9600 (1200)	Baud rate of unit must match connected equipment.
PArb	Parity bit	odd, even, no parity (odd)	Parity of unit must match other equipment.
Add	Unit address	0 to 99 (0)	For multiple units, each unit must have a unique address.
Abr	Abbreviated or full transmission	yes/no (no)	Selecting yes, the controller does not transmit mnemonics.
PrAt	Auto print rate	0 to 9999 (0)	0 disables auto print function
PoPt	Print options	yes/no (no)	Selecting yes allows print options shown below, to be programmed.
INP	Input Process Value	yes/no (yes)	
SEt	Setpoint	yes/no (yes)	
OPr	% Output Power	yes/no (yes)	
Pbd	% Proportional Band	yes/no (no)	
INt	Integral Time	yes/no (no)	
dEr	Derivative Time	yes/no (no)	
AL1	Alarm 1	yes/no (no)	

Display	Parameter	Range and Units (Factory Setting Value)	Description/ Comments
AL2	Alarm 2	yes/no (no)	
dEv	Deviation From Setpoint	yes/no (no)	
OFP	% Output Power Offset	yes/no (no)	
r_P	Setpoint Ramp Rate	yes/no (no)	
Crg	Relative Gain	yes/no (no)	
Cdb	Deadband	yes/no (no)	
OSt	Output Status	yes/no (no)	
rAt	Remote Setpoint Ratio	yes/no (no)	
bIA	Remote Setpoint Bias	yes/no (no)	
Pb2	Secondary Proportional Band	yes/no (no)	
It2	Secondary Integral Time	yes/no (no)	
dt2	Secondary Derivative Time	yes/no (no)	
rSP	Remote Setpoint	yes/no (no)	
SP2	Secondary Directed Setpoint	yes/no (no)	
IN2	Second Analog Input	yes/no (no)	

Configure Module 7 - Second Analog Input (7-2N)

Unit returns to configuration access point if Second Analog Input option is not installed.

Display	Parameter	Range and Units (Factory Setting Value)	Description/ Comments
OPEr	Second Analog Input operation mode	CSCd - Internal Cascade mode rSP - Remote Setpoint mode (rSP)	Remote Setpoint mode also for External Cascade
root	Square root linearization	yes/no (no)	Linearization applies to the Second Input
dPt2	Second Input decimal point position	0, 0.0, 0.00 or 0.000 (0.0)	Normally same position as main input for Remote Setpoint
dSP1	Second Input scaling point #1 display value	-999 to 9999 (0.0)	Normally key-in process low value
INP1	Second input scaling point #1 input value	-9.99 to 99.99 (4.00)	Either key-in value or press DSP for measure/record mode
dSP2	Second Input scaling point #2 display value	-999 to 9999 (100.0)	Normally key-in process high value
INP2	Second input scaling point #2 input value	-9.99 to 99.99 (20.00)	Either key-in value or press DSP for measure/record mode
SPtr	Local/Remote Setpoint transfer action	nor - normal Auto - automatic trAC - track (nor)	Applies only to Remote Setpoint mode.
OPd2	Secondary output power dampening	0 to 250 seconds (2)	0=off

Configure Module 8 - Valve Positioner (8-VP)

Unit returns to configuration access point if Valve Positioner option is not installed.

Display	Parameter	Range and Units (Factory Setting Value)	Description/ Comments
VPS1	Valve position #1	-99.9 to 999.9% (0.0)	Normally full closed valve position. Either key-in value or press DSP for <u>measure/record mode</u>
VPS2	Valve position #2	-99.9 to 999.9% (100.0)	Normally full open valve position. Either key-in value or press DSP for <u>measure/record mode</u>
VUdt	Valve update time	0 to 250 seconds (10)	0 = update at a rate of 10/sec.
VPdb	Valve position deadband	0.1 to 25.0% (2.5)	Adjust to reduce hunting and valve activity (Position mode only)
VFAL	Valve fail time alarm	0 to 9999 seconds (0)	0=off, set value larger than update time plus motor transit time (Position mode only)
VOPt	Valve motor open time	1 to 9999 seconds (30)	Measure actual valve motor open time (Velocity mode only)
VCLt	Valve motor close time	1 to 9999 seconds (30)	Measure actual valve motor close time (Velocity mode only)
VOnt	Valve minimum on time	0.1 to 25.0 seconds (1.0)	Adjust to reduce hunting and valve activity (Velocity mode only)

Configure Module 9 - Factory Service Operations (9-FS)

Display	Parameter	Range and Units (Factory Setting Value)	Description/ Comments
Code	Enter factory service function code.	48 - Calibrate instrument	Refer to Calibration Section for details.
		66 - Reset parameters to factory settings	

RS485 SERIAL COMMUNICATIONS INTERFACE

RS485 communications allows for transmitting and receiving of data over a single pair of wires. This optional feature can be used for monitoring various values, resetting output(s), and changing values, all from a remote location. Typical devices that are connected to a PCU unit are a printer, a terminal, a programmable controller, or a host computer.

The RS485 differential (balanced) design has good noise immunity and allows for communication distances up to 4,000 feet. Up to thirty-two units can be connected on a pair of wires and a common. The RS485 common is isolated from the controller input signal common to eliminate ground loop problems associated with the input probe. The unit's address can be programmed from 0 to 99. An optional RLC Serial Converter Module GCM422 (RS-422 to 20 mA current loop) can be installed to expand the unit's flexibility.

COMMUNICATION FORMAT

The half-duplex communication operation sends data by switching voltage levels on the common pair of wires. Data is received by monitoring the levels and interpreting the codes that are transmitted. In order for data to be interpreted correctly, there must be identical formats and baud rates between the communicating devices. The formats available for the PCU unit are 1 start bit, 7 data bits, No parity (parity equals extra stop bit) or 1 parity bit (odd or even) and 1 stop bit. The programmable baud rates are; 300, 600, 1200, 2400, 4800, or 9600 baud.

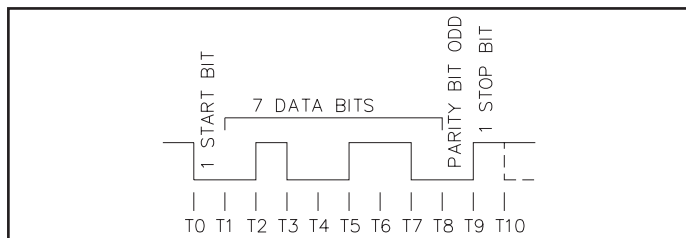

Figure 21, 10 Bit Data Format,

Before serial communication can take place, the unit must be programmed to the same baud rate and parity as the connected equipment. In addition, the loop address number and print options should be known. When used with a terminal or host computer and only one unit is employed, an address of zero may be used to eliminate the requirement for the address specifier when sending a command. If more than one unit is on the line, each unit should be assigned a different address number.

SENDING COMMANDS AND DATA

When sending commands to a PCU unit, a command string must be constructed. The command string may consist of command codes, value identifiers, and numerical data. Below is a list of commands and value identifiers that are used when communicating with the PCU unit.

Command	Description
N (4EH)	Address command; Followed by a one or two digit address number 0-99.
P (50H)	Transmit print options command; Transmits the options selected in the Program Options (PoPt) section.
R (52H)	Reset command; Followed by one of the Value Identifiers (G or H).
T (54H)	Transmit value command; Followed by one of the Value Identifiers (A-M, O, Q, W-Z, AA, or BB).
C (43H)	Control action command; Followed by the Value Identifier (S or U) and number.
V (56H)	Change value command; Followed by one Value Identifier (B-H, J-M, O, Q, or X-Z), then the proper numerical data.

SENDING COMMANDS AND DATA (Cont'd)

VALUE IDENTIFIER	DESCRIPTION	SERIAL MNEMONIC	UNITS
A	Input Display Value	INP	U
B	Setpoint	SET	U
C	Output Power	PWR	%
D	Proportional Band	PBD	%
E	Integral Time	INT	S
F	Derivative Time	DER	S
G	Alarm 1	AL1	U
H	Alarm 2	AL2	U
I	Deviation	DEV	U
J	Output Power Offset	OPF	%
K	Setpoint Ramp Rate	RMP	R
L	Relative Gain	CRG	G
M	Deadband	CDB	U
O	Remote Setpoint Ratio	RAT	R
Q	Remote Setpoint Bias	BIA	U
S	Controller Mode	1 -Automatic 2 - Manual (User)	
U	Setpoint Mode	1 – Local 2 - Remote	
W	Output status*	OST	U
X	Secondary Proportional Band	PB2	%
Y	Secondary Integral Time	IT2	S
Z	Secondary Derivative Time	DT2	S
AA	Second Input Reading	IN2	U
BB	Remote Setpoint Reading or Secondary Directed Setpoint	RSP or SP2	U

Output status transmission format = ABCD (0 = output off, 1 = output on)

Note: The % output power can be changed only if the controller is in the manual mode of operation.

* The output status indicates the status of the controller's outputs. The status can only be read (see the following table). The alarms outputs may be reset by the reset operator(R).

Output Status

NON-VALVE POSITIONER MODELS	VALVE POSITIONER MODELS
A = Main output (OP1)	A = Alarm 1 output(AL1)
B = Secondary output (OP2)	B = 0
C = Alarm 2 output (AL2)	C = Motor close output(CLS)
D = Alarm 1 output (AL1)	D = Motor open output(OPN)

Example:

OP1 = ON, OP2 = OFF, AL2 = OFF, AL1 = ON

Transmission = "OST 1001"

Note: The % output power can be changed only if the controller is in the manual mode of operation.

The command string is constructed by using a command, a value identifier, and a data value if required. The Data value need not contain the decimal point since it is fixed within the unit, when programmed at the front panel. The PCU accepts the decimal point, however it does not interpret them in any way. Leading zeros can be eliminated, but all trailing zeros must be present.

Example: If an alarm value of 750.0 is to be sent, the data value can be transmitted as 750.0 or 7500. If a 750 is transmitted, the alarm value changes to 75.0 in the unit.

The address command allows a transmission string to be directed to a specific unit on the serial communications line. When the unit address is zero, transmission of the address command is not required. For applications that require several units, it is recommended that each unit on the line be assigned a specific address.

If they are assigned the same address, a Transmit Value Command causes all the units to respond simultaneously, resulting in a communication collision. The command string is constructed in a specific logical sequence. The PCU does not accept command strings that do not follow this sequence. Only one operation can be performed per command string.

The following procedure should be used when constructing a command string.

1. The first two to three characters of the command string must consist of the Address Command (N) and the address number of the unit (0-99). If the unit address is zero, the address command and number need not be sent.
2. The next character in the command string is the command that the unit is to perform (P, R, T, C, or V).
3. A Value Identifier is next if it pertains to the command. The command P (print) does not require a Value Identifier.
4. The numerical data is next in the command string if the “Change Value” or “Control Action” command is used.
5. All command strings must be terminated with an asterisk * (2AH). This character indicates to the unit that the command string is complete and the unit begins processing the command.

Below are typical examples of command strings.

Example: Change Proportional Band Value to 13.0% on the unit with an address of 2.

Command String: N2VD130*

Example: Transmit the Input Display Value of the unit with an address of 3.

Command String: N3TA*

Example: Reset Alarm Output 1 of the unit with an address of 0.

Command String: RG*

If illegal commands or characters are sent to the PCU, the string must be re-transmitted.

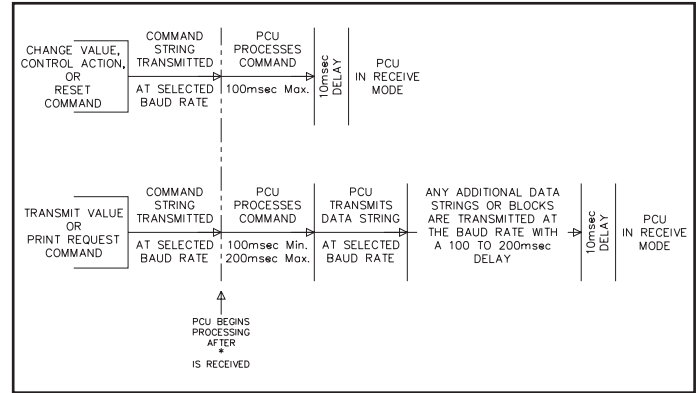

Figure 22, Timing Diagrams

When writing application programs in BASIC, the transmission of spaces or carriage return and line feed should be inhibited by using the semicolon delimiter with the “PRINT” statement. The unit does not accept a carriage return or line feed as valid characters.

It is recommended that a “Transmit Value” command follow a “Change Value” Command. If this is done, the reception of the data can provide a timing reference for sending another command and insures that the change has occurred. When a “Change Value or Reset” command is sent to the unit, there is time required for the unit to process the command string. Figure 22, Timing Diagrams, shows the timing considerations that need to be made.

RECEIVING DATA

Data is transmitted from the PCU when a “T” Transmit Value or a “P” Transmit Print Options command is sent to the unit via the serial port. Data is also transmitted when the User Input, programmed for the Print Request function, is activated. The print rate feature allows the selected print options to be transmitted at a programmable rate over the serial port. The format for a typical transmission string with mnemonics is shown in Figure 23, Typical Transmission String:

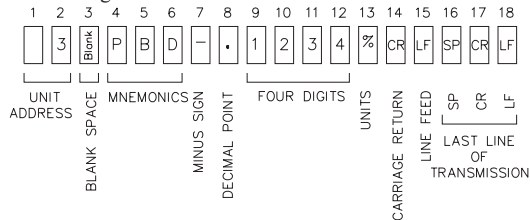

Figure 23, Typical Transmission String

The first two digits transmitted are the unit address. If the unit address is 0, the first two digits are blank. A space follows the unit address digits. The next three characters are the mnemonics followed by one or more blank spaces. The numerical data value is transmitted next followed by the identifying units. Negative values are indicated by a “-” sign.

The decimal point position “floats” within the data field depending on the actual value it represents. The numeric data is right justified without leading zeros.

When a “T” command or print request is issued, the above character string is sent for each line of a block transmission. An extra <SP><CR><LF> is transmitted following the last line of transmission from a print request, to provide separation between print-outs.

If abbreviated transmission is selected, only numeric data is sent. If abbreviated transmission is not selected, the unit transmits mnemonics and the numeric data.

If more than one string is transmitted there is a 100 msec minimum to 200 msec maximum built-in time delay after each transmission string and after each block of transmission. When interfacing to a printer, sending mnemonics are usually desirable.

Examples of transmissions are shown below:

- 1 INP 500U<CR><LF>100 - 200 msec Mnemonics Sent
- 1 SET 525U<CR><LF>100 - 200 msec
- 1 PWR 20%<SP><CR><LF><SP><CR><LF>100 - 200 msec
- 673.5<CR><LF>100 - 200 msec No Mnemonics Sent

The Print Options provide a choice of which PCU data values are to be transmitted. The PCU transmits the Print Options when either the User Input, programmed for the print request function is activated, a “P” (Transmit Print Options) command is sent to the PCU via the serial port, or the Automatic Print Rate is set for a specific time. The Print Options are programmed in the Serial Communications Module (6-SC) with the available options:

1. Print Input Display Value.
2. Print Setpoint Value.
3. Print % Output Power Value.
4. Print % Proportional Band Value.
5. Print Integral Time Value.
6. Print Derivative Time Value.
7. Print Alarm 1 Value.
8. Print Alarm 2 Value.
9. Print Deviation From Setpoint Value.
10. Print % Output Power Offset Value.
11. Print Setpoint Ramp Rate Value.
12. Print Relative Gain Value.
13. Print Deadband Value.
14. Print Output Status
15. Print Remote Setpoint Ratio
16. Print Remote Setpoint Bias
17. Print Proportional Band #2
18. Print Integral Time #2
19. Print Derivative Time #2
20. Print Second Input Reading
21. Print Remote Setpoint Reading
22. Print Secondary Setpoint Value

A print-out from a PCU unit with an address of 1 and all print options selected is shown below:

1 INP 500U
1 SET 525U
1 PWR 20.0%
1 PBD 4.0%
1 INT 120S
1 DER 30S
1 AL1 600U
1 AL2 475U
1 DEV -25U
1 OFP 0.0%
1 RMP 0.0R
1 CRG 1.0G
1 CDB OU
1 OS_t 1001
1 RA_t 1.000R
1 BIAS 0U
1 Pb₂ 4.0%
1 It₂ 120S
1 dt₂ 30S
1 IN₂ 100.0U
1 RSP 0U
1 SP₂ 0.0U

Note: If the secondary output option is installed, AL2 is not printed or functional.

SERIAL CONNECTIONS

When wiring the terminal block at the rear of the unit, refer to the label with the terminal description for installing each wire in its proper location. It is recommended that shielded (screened) cable be used for serial communications. This unit meets the EMC specifications using Alpha #2404 cable or equivalent. There are higher grades of shielded cable, such as four conductor twisted pair, that offer an even higher degree of noise immunity. Only two transceiver wires and a common are needed.

The two data (transceiver) wires connect to the TX/RX(+) and TX/RX(-) terminals, appropriately.

The cable should consist of a shielded twisted pair and in some applications a signal ground may be required to establish a ground reference. The signal ground is required if the equipment does not have internal bias resistors connected to the RS485 transceiver lines. The signal ground is connected at the RS485 common of only one PCU unit to the RS485 equipment. If necessary, the shield can be used as the signal ground.

The signal input common is isolated from the RS485 common and the analog output “-” terminal.

Note: Do not connect any of the commons to the analog output “-” terminal.

Terminal Descriptions

RS485 COMM. - Common may be required for communication hook-up.

TX/RX(+) & TX/RX(-) - The PCU transmits and receives on these two terminals which are connected to the external device.

TX EN. - Used with a Red Lion Controls (RLC) GCM422 Serial Converter Module (RS422 to 20 mA Loop). Otherwise not normally used.

Note: Some models do not have TX EN. This is an output used in conjunction with interface converter Model GCM422, to convert RS485 to 20 mA current loop.

Connecting To A Host Terminal

Six PCU units are used to control a process in a plant. The PCU units are located at the proper location to optimize the process. A communication line is run to an industrial computer located in the production office. Figure 24, Connecting To A Host Terminal, shows the line connection. Each PCU is programmed for a different address and all are programmed for the same baud rate and parity as the computer. An application program is written to send and receive data from the units using the proper commands.

TROUBLESHOOTING SERIAL COMMUNICATIONS

If problems are encountered when interfacing the PCU(s) and host device or printer, the following check list can be used to help find a solution.

1. Check all wiring. Refer to the previous application examples and use them as a guide to check your serial communication wiring. Proper polarity of all units and other peripherals must be observed.
2. If the PCU is connected to a host computer, device or printer, make sure that the computer or device is configured with the same baud rate and communication format as the PCU. The communication format the PCU accepts is; 1 start bit, 7 data bits, no parity or 1 parity bit (odd or even), and 1 stop bit.
3. Check the PCU's unit address. If the Address command is not used when transmitting a command to the PCU, the PCU's address must be set to 0. See *Sending Commands & Data*, page 47, for command structure.
4. If two-way communications are to be established between the PCU and a computer, the computer must receive a transmission from the PCU first. Activating the User Input, programmed for the print request function, initiates transmissions from the PCU.
5. When sending commands to the PCU, an asterisk (2Ah) must terminate the command. After system power-up an asterisk must be sent to clear the PCU input buffer.
6. In multiple unit configurations, each unit must have a different address other than zero.
7. If all of the above has been done, try reversing the polarity of the transceiver wires between the PCU(s) and the RS485 interface card. Some cards have the polarity reversed.

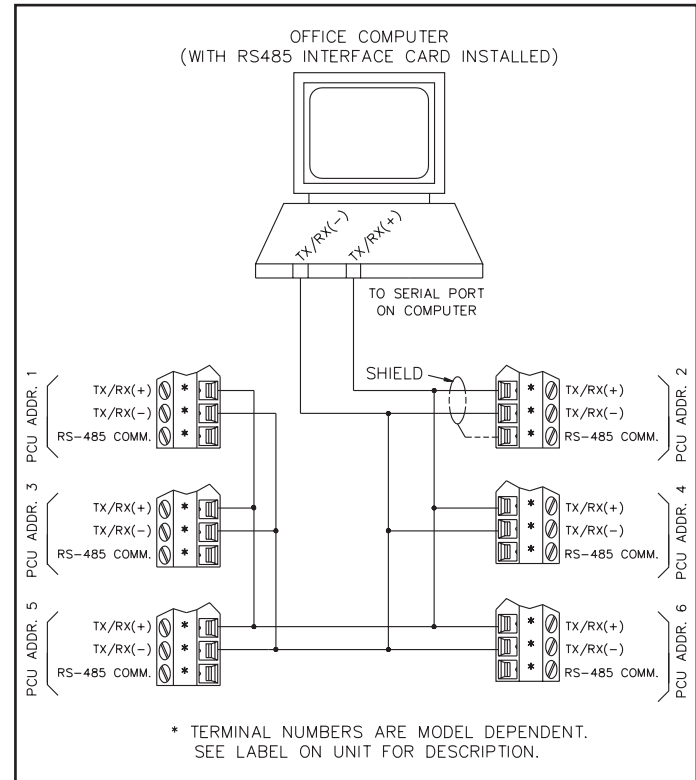

Figure 24, Connecting To A Host Terminal

VALVE POSITION OPTION

The Valve Position option of the PCU directly controls the position of a valve. The Valve Motor Open and Valve Motor Close outputs independently activate the valve motor to position the valve for closed loop control. The PCU is capable of two Valve Position control modes: Position mode, in which valve position slidewire feedback is used by the controller, and Velocity mode, a special positioning algorithm in which no slidewire signal is required.

POSITION MODE VALVE CONTROL

In Position mode valve control, the slidewire resistance, representing the valve position, is measured by the PCU and scaled internally to equal 0% to 100%. The scaled valve position is compared with the output power to determine if the valve needs to be repositioned. Since the output power and valve position both range from 0% to 100%, and normally equal each other, the output power display (%PW) represents valve position. Based on this information, the valve can be positioned manually from the Manual (USER) mode of the controller. The output power can be manually ranged from 0% to 100% to position the valve.

In the event that the valve position feedback and the output power do not agree, due to a faulty valve motor, binding valve or defective slidewire, a valve fail alarm occurs, if desired. The valve fail alarm is based on a timer in which the output power and valve feedback positions must match within a preset time. A display message of "VALV" occurs in this event. Optionally, an alarm event output can be programmed to signal the event to other equipment. Once the alarm triggers, the output power and feedback positions must match to silence the alarm. Setting the valve fail time parameter to zero disables this feature and also silences a triggered alarm.

The controller also senses loss of slidewire feedback signal and can activate the open or close outputs in such an event. See *Input Overdrive Preset Power (OPFL)*, page 25, for a description of this operation.

Example:

Steam is used to heat water by passing it through a heat exchanger. Variations in inlet water temperature, steam pressure, hot water demand, etc., all contribute to the need for closed loop control. The steam pressure is controlled by a PCU with Valve Positioner option. A valve positioner with 1,000 ohm slidewire feedback is used. The PCU maintains constant hot water temperature by controlling the position of the valve. Given the time

constant of the process is 60 seconds, the Valve Update Time (VUdt) of the controller is set at five seconds to reduce valve activity. Adding Valve Update Time to the valve motor transit time (20 seconds), the valve fail time is set at 50 seconds [$2 * (20+5)$] to alert for a valve fail condition. The valve position hysteresis is set at 2.0% to allow for valve motor overrun and backlash, and also to provide a control deadband to reduce valve activity. A minimum valve position is set to 20% to allow a minimum amount of steam flow into the heat exchanger. The maximum valve position is set at 100%. The following data is used to configure the Position mode valve control parameters of the PCU:

VPS1	20.0	Scale minimum valve position to 20.0%
VPS2	100.0	Scale maximum valve position to 100.0%
VUdt	5	Update valve position, at most, once every 5 seconds
VPdb	2.0	Set valve position deadband to 2.0%
VFAL	50	Set valve fail timer to 50 seconds

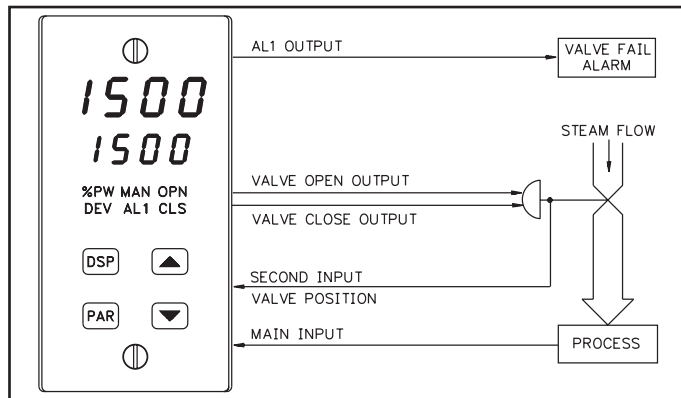

Figure 25, Motorized Valve Positioner

VELOCITY MODE VALVE CONTROL

The Velocity mode of the Valve Positioner option is a special valve control algorithm that does not use a slidewire feedback signal. In this control mode, the controller responds with changes in output power instead of responding to the output power directly, as in Position mode. Subsequently, as long as there is process error, the controller activates the motor control outputs periodically to eliminate the error.

The valve motor open and close transit time and minimum motor on-time are required parameters for Velocity mode. The valve motor transit times should be measured in actual use as they frequently differ from the nominal valve motor times. The minimum on-time is another Velocity mode parameter. It establishes the control deadband of the controller. Minimum on times that are too short could cause excessive valve activity. Minimum on-times that are too long may cause too much error. Velocity mode of the controller is engaged by setting both Valve Position parameters to 0.0%.

Example:

Steam is used to heat water by passing it through a heat exchanger. Variations in inlet water temperature, steam pressure, hot water demand, etc., all contribute to the need for closed loop control. The steam pressure is controlled by a PCU with Valve Positioner option. The PCU maintains constant hot water temperature by controlling the position of the valve. No slidewire feedback is used. Given the time constant of the process is 60 seconds, the Valve Update Time (VUdt) of the controller is set at five seconds to reduce valve activity. The valve motor open and close transit times were measured at 20 and 25 seconds respectively. The minimum on time pulse is set at 0.5 seconds to allow for valve motor overrun and backlash, and also to provide for a control deadband. The effective control deadband expressed in percent of controller output is:

$$\begin{aligned}\text{Effective deadband (in percent)} &= \frac{Vont}{0.5 * (Vopt + VCLt)} \\ &= \frac{0.5}{0.5 * (20 + 25)} \\ &= 2.2\%\end{aligned}$$

The following data is used to configure the Velocity mode valve control parameters of the PCU:

VPS1	0.0	Set valve position #1 to 0.0 to engage Velocity mode
VPS2	0.0	Set valve position #2 to 0.0 to engage Velocity mode
VUdt	5	Update valve position, at most, once every 5 seconds
VOpt	20	Set valve motor open time to 20 seconds
VCLt	25	Set valve motor close time to 25 seconds
Vont	0.5	Set valve motor minimum on time (deadband) to 0.5 seconds

SECOND ANALOG INPUT OPTION

The Second Analog Input option is an additional analog input used for Remote Setpoint or Internal Cascade operation. The mode of operation is selected by programming. The Second Analog Input reading can be viewed in the secondary display. Front panel annunciator SEC illuminates to indicate this display mode.

REMOTE SETPOINT

The PCU with Second Analog Input can be configured as a Remote Setpoint. This mode of operation enables Cascade control (external), Ratio control and Process Setpoint Slave control, among others.

The Remote Setpoint value used internally by the controller is:

$$\begin{aligned}\text{Remote Setpoint} &= (\text{Scaled Second Analog Input} * \text{rtio}) + \text{BIAS} \\ \text{where rtio} &= 0.000 \text{ to } 9.999 \\ \text{BIAS} &= -999 \text{ to } 9999\end{aligned}$$

The rtio and BIAS parameters offer on-line scaling of the Remote Setpoint to adjust control ratios or biases among related processes.

In Remote Setpoint mode, the front panel annunciator REM is illuminated. When in Local Setpoint mode, this annunciator is off. In either Local or Remote Setpoint mode, the Manual (USER) mode is indicated by the REM annunciator flashing.

The Remote Setpoint is restricted to the setpoint limit values SPLO and SPHI. These parameters may be used to limit the range of the Remote Setpoint to a safe or more stable control range. For Remote Setpoint signal sources that change wildly or are too sensitive to process upsets, the Setpoint Ramp parameter (SPrP) can be used to ramp (rate limit) the Remote Setpoint reading. This can subsequently reduce the fluctuations of the Secondary control loop.

Flow Ratio Control

Example: For processing purposes, it is necessary to control the flow of one process with respect to the flow rate of another. The PCU is to control the flow at a ratio of 1.5x that of the uncontrolled flow. The PCU with Remote Setpoint programmed for a ratio value of 1.500 (rtio) and a bias value of 0 (bias) suits this application.

Process Remote Setpoint Slave Control

Example: Multiple PCUs are used to regulate the temperature zones of a continuous drying oven. To reduce thermal shock to the product, the setpoint levels of incoming zone controllers are low, while the other controllers have setpoints that are increasingly ramped up to the ideal drying temperature. The PCUs are slave controllers that have Remote Setpoint with unique bias values to implement the ramp in setpoint values of the drying oven. One PCU is the master controller. The master controller re-transmits the setpoint value via the linear DC output (4 to 20 mA) to the slave zone controllers. The slave zone controllers receive the 4 to 20 mA signal as a Remote Setpoint.

CASCADE CONTROL

Cascade control involves the separation of a process into two control loops: the Primary and the Secondary.

The Secondary control loop is designed to regulate the manipulated variable which is normally the faster responding variable. The Primary loop controller establishes this setpoint to the Secondary to maintain Primary loop regulation. Disturbances occurring to the Secondary control loop are quickly compensated for, before the effect appears in the Primary loop output. This early loop compensation or “feed forward” action of Cascade control can improve control quality compared with standard single loop control. Since the Primary and Secondary “see” different processes, they normally have different tuning values, with the Secondary normally faster responding.

The PCU is capable of two modes of Cascade control: External Cascade and Internal Cascade. External cascade involves the use of two controller units, one of which is a Remote Setpoint controller. Internal Cascade has both the Primary and Secondary control loops implemented within one controller unit.

External Cascade Control

External Cascade Control involves the use of two controllers, one of which has a Remote Setpoint Input.

The outer loop controller (Primary controller) directs the setpoint of the inner loop controller (Secondary controller) through the linear DC 4 to 20 mA output. The Secondary controller has a Second Analog Input option configured as a Remote Setpoint (RSP) in order to receive the directed setpoint. See Figure 26, for more details.

The Remote Setpoint of the Secondary controller must be scaled prior to tuning the controllers. Normally, the Remote Setpoint is scaled to equal the actual process range of the secondary. Scaled in this way, the Primary controller can direct the setpoint of the Secondary controller over its operating range. The internal Remote Setpoint value is as follows:

Remote Setpoint = (Scaled Second Analog Input * Ratio Parameter) + Bias Parameter

Example: A TCU (temperature input) and PCU (process input) are used in an External Cascade arrangement to regulate the temperature of a large dye vat. The PCU is the Secondary controller with Remote Setpoint to regulate steam pressure. The TCU is the primary controller with linear DC output which directs the setpoint of the Secondary controller in order to maintain vat temperature. The range of the secondary steam process is 0.0 to 200.0 PSI.

The following data configures the Remote Setpoint of the PCU:

OPEr	- rSP	Select Remote Setpoint mode
root	- NO	No square root linearization necessary
dPt2	- 0.0	Select decimal point position to match that of main input
dSP1	- 0.0	Scale Remote Setpoint to match main input range of PCU
INP1	- 4.00	Scale input range to match 4 to 20 mA output of TCU
dSP2	- 200.0	Scale Remote Setpoint to match main input range of PCU
INP2	- 20.00	Scale input range to match 4 to 20 mA output of TCU
SPtr	- Auto	Select bumpless Local/Remote setpoint transfer

In some cases the Remote Setpoint signal may change too rapidly or have excessive process noise. This may lead to instability or even oscillation of the Secondary controller. The Setpoint Ramp parameter (SPrP) is effective in limiting the amount of change of the Remote Setpoint. The Setpoint Ramp parameter should be set to a minimum ramp value consistent with the response time of the Primary process. Additionally, Setpoint Limit Low and Setpoint Limit High parameters (SPLO, SPHI) may be used to constrain the Remote Setpoint value to safe limits or narrow the operating range for stability purposes.

See *Auto-Tune*, page 64, for tuning procedure of External Cascade controllers.

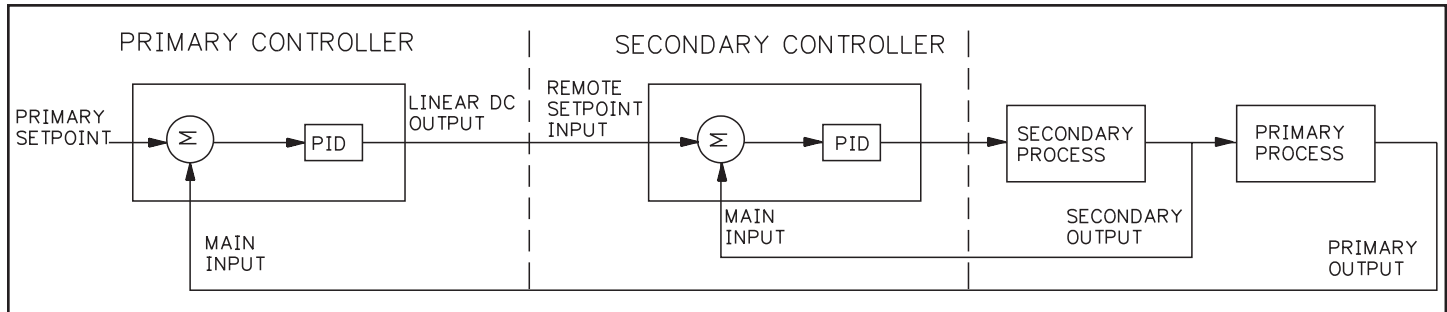

Figure 26, External Cascade

Internal Cascade Control

The Internal Cascade control mode of the PCU embodies the function of two Cascade controllers into a single unit. In all other respects, Internal Cascade yields the same control flexibility and control quality as External Cascade.

In Internal Cascade, the Primary loop provides an internal setpoint for the Secondary loop. The Primary loop output power (0-100%) is scaled internally by the “DSP1” and “DSP2” scaling parameters to yield the Secondary (directed) setpoint. This setpoint is used by the secondary loop to calculate the actual output (physical output). The setpoint can be viewed during operation by the SP-2 parameter. See Figure 27, for more details.

For proper Auto-Tuning of the Primary loop, it is necessary that “DSP1” and “DSP2” represent the actual process low and process high values, respectively, of the Secondary process. The tuning parameters (Prop, Intt, dErt, OPdP) pertain to the primary loop and the tuning parameters (Pb-2, It-2, dt-2, OPd2) pertain to the secondary loop.

Example: A PCU with Second Analog Input is used in an Internal Cascade arrangement to regulate the temperature of a large dye vat. The Second Analog Input is the input to the Secondary loop. This loop regulates steam pressure. The Primary loop (temperature) directs the setpoint of the Secondary to maintain vat temperature. The range of the Secondary steam process is 0.0 to 200.0 PSI transmitted by a 4 to 20 mA transducer. The following data configures the Internal Cascade controller:

OPeR	- CSCd	Select Internal Cascade mode
root	- NO	No square root linearization necessary
dPt2	- 0.0	Select decimal point position for 0.0 PSI
dSP1	- 0.0	Secondary process display low value (0.0 PSI)
INP1	- 4.00	Secondary process transmitter low value (4 mA)
dSP2	- 200.0	Secondary process display high value 200.0 PSI)
INP2	- 20.00	Secondary process transmitter high value (20 mA)
OPd2	- 2	Secondary output power (physical output) dampening

The Secondary process value can be monitored during operation in the secondary display.

See *Auto-Tune*, page 64, for tuning procedure of Internal Cascade controllers.

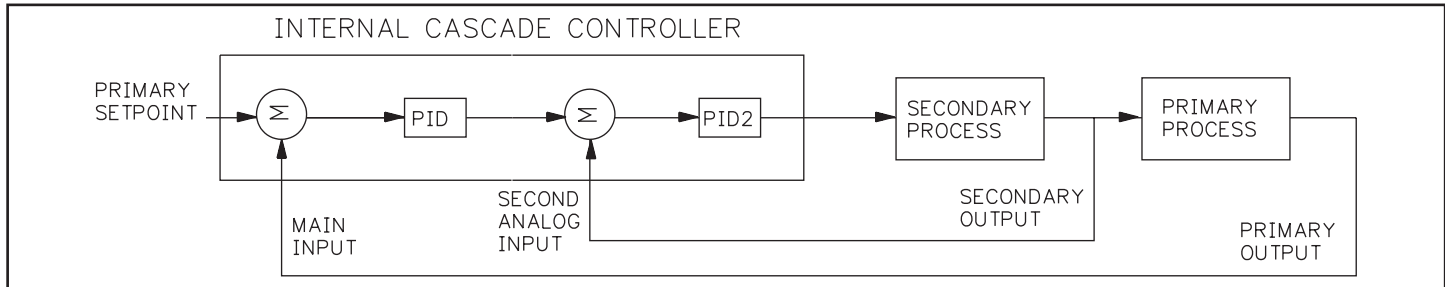

Figure 27, Internal Cascade

PID CONTROL

PROPORTIONAL BAND

Proportional band is defined as the “band” of units the process changes to cause the percent output power to change from 0% to 100%. The band may or may not be centered about the setpoint value depending upon the steady state requirements of the process. The band is shifted by manual offset or integral action (automatic reset) to maintain zero error. Proportional band is expressed as percent of scaled display range.

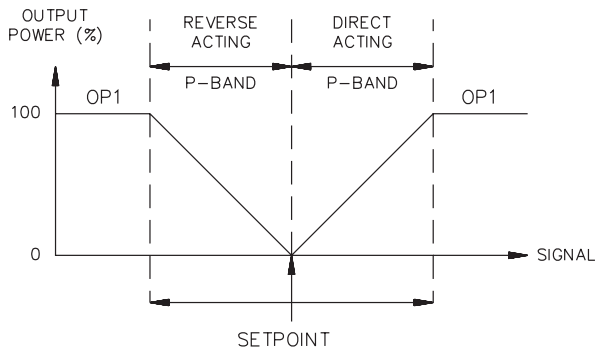

Figure 28, Proportional Band

The proportional band should be set to obtain the best response to a disturbance while minimizing overshoot. Low proportional band settings (high gain) result in quick controller response at expense of stability and increased overshoot. Settings that are excessively low produce continuous oscillations at setpoint. High proportional band settings (low gain) result in a sluggish response with long periods of process “droop”. A proportional band of 0.0% forces the controller into ON/OFF control mode with its characteristic cycling at setpoint (See *ON/OFF Control*, page 62, for more information).

INTEGRAL TIME

Integral time is defined as the time, in seconds, in which the output due to integral action alone equals the output due to proportional action with a constant process error. As long as a constant error exists, integral action repeats the proportional action every integral time. Integral action shifts the center point position of the proportional band to eliminate error in the steady state. The units of integral time are seconds per repeat.

Integral action (also known as “automatic reset”) changes the output power to bring the process to setpoint. Integral times that are too fast (small times) do not allow the process to respond to the new output value. This causes over compensation and leads to an unstable process with excessive overshoot. Integral times that are too slow (large times) cause a slow response to steady state errors. Integral action may be disabled by setting the time to zero. If time is set to zero, the previous integral output power value is maintained.

If integral action is disabled, manual reset is available by modifying the output power offset (“OPOF” initially set to zero) to eliminate steady state errors. This parameter appears in unprotected parameter mode when integral time is set to zero. The controller has this feature to prevent integral action when operating outside the proportional band. This prevents “reset wind-up”.

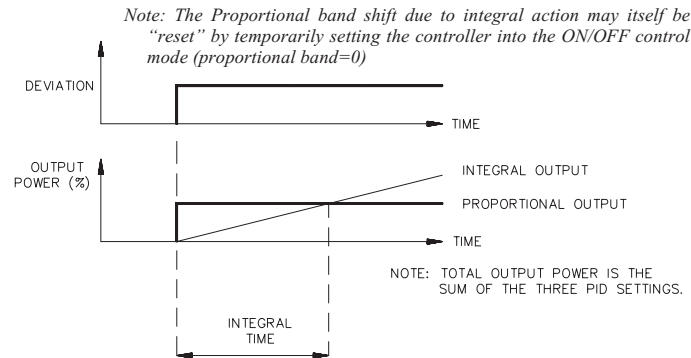

Figure 29, Integral Time

DERIVATIVE TIME

Derivative time is defined as the time, in seconds, in which the output due to proportional action alone equals the output due to derivative action with a ramping process error. As long as a ramping error exists, the derivative action is “repeated” by proportional action every derivative time. The units of derivative time are seconds per repeat.

Derivative action is used to shorten the process response time and helps to stabilize the process by providing an output based on the rate of change of the process. In effect, derivative action anticipates where the process is headed and changes the output before it actually “arrives”. Increasing the derivative time helps to stabilize the response, but too much derivative time coupled with noisy signal processes, may cause the output to fluctuate too greatly, yielding poor control. None or too little derivative action usually results in decreased stability with higher overshoots. No derivative action usually requires a wider proportional and slower integral times to maintain the same degree of stability as with derivative action. Derivative action is disabled by setting the time to zero.

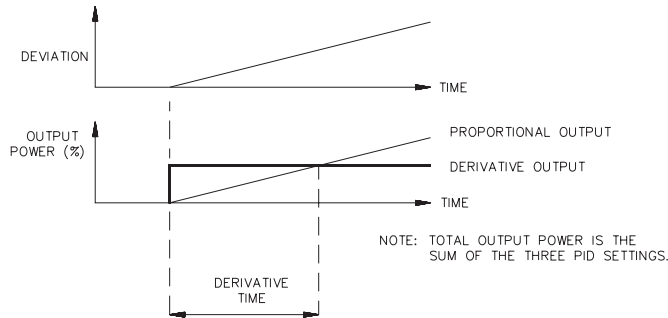

Figure 30, Derivative Time

OUTPUT POWER OFFSET (MANUAL RESET)

If the integral time is set to zero (automatic reset is off), it may be necessary to modify the output power to eliminate errors in the steady state. The output power offset (OPOF) is used to shift the proportional band to compensate for errors in the steady state. The output power offset (OPOF) parameter appears in the unprotected mode, if the integral time equals zero. If integral action (automatic reset) is later invoked, the controller continues from the previous output power offset and updates accordingly.

PID ADJUSTMENTS

To aid in the adjustment of the PID parameters for improved process control, a chart recorder is necessary to provide a visual means of analyzing the process. Compare the actual process response to the PID response figures with a step change to the process. Make changes to the PID parameters in no more than 20% increments from the starting value and allow the process sufficient time to stabilize before evaluating the effects of the new parameter settings.

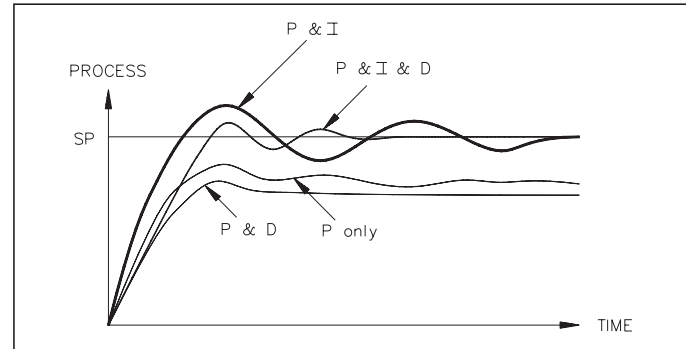

Figure 31, Typical Response Curve

PID ADJUSTMENTS (Cont'd)

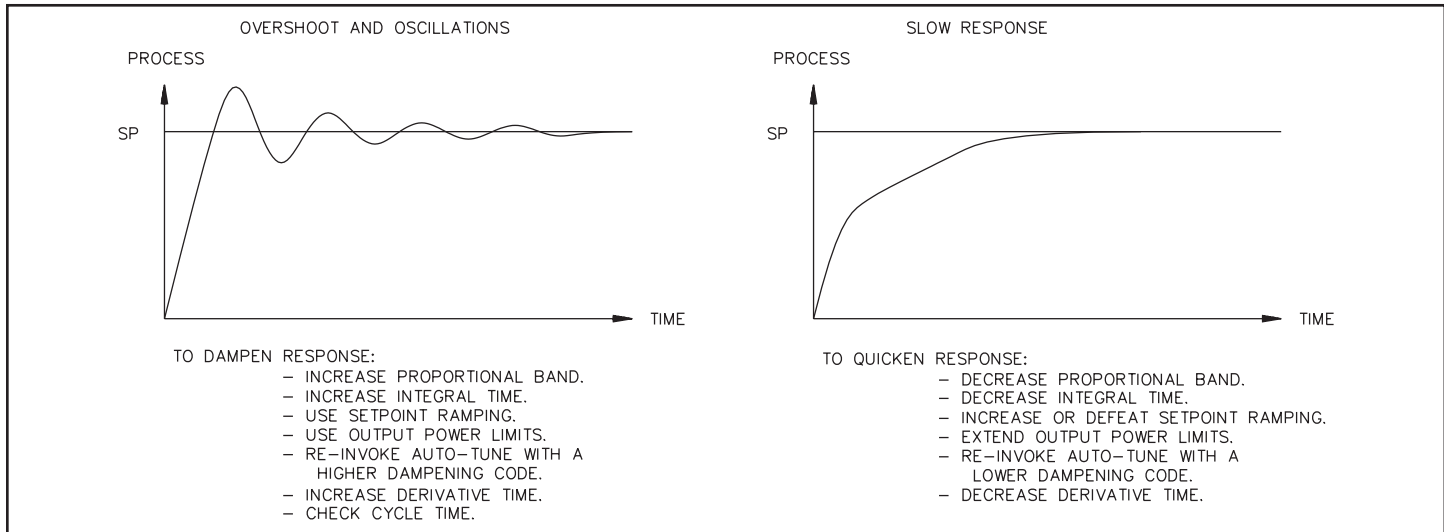

Figure 32, Process Response Extremes

ON/OFF CONTROL

The controller operates in the ON/OFF control mode by setting the proportional band = 0.0%. The ON/OFF control hysteresis band (CHYS) parameter eliminates output chatter around setpoint. The Secondary output can also be used in the ON/OFF control by setting the relative gain = 0.0 (GAN2). Additionally, the deadband parameter (db-2) determines the amount of operational deadband or overlap between the two outputs.

The phase of the control action can be reversed by the output control action parameter. ON/OFF control is usually characterized by signal oscillations about the setpoint value. Large hysteresis values make the oscillations larger. ON/OFF control should only be used where the constant oscillations are acceptable.

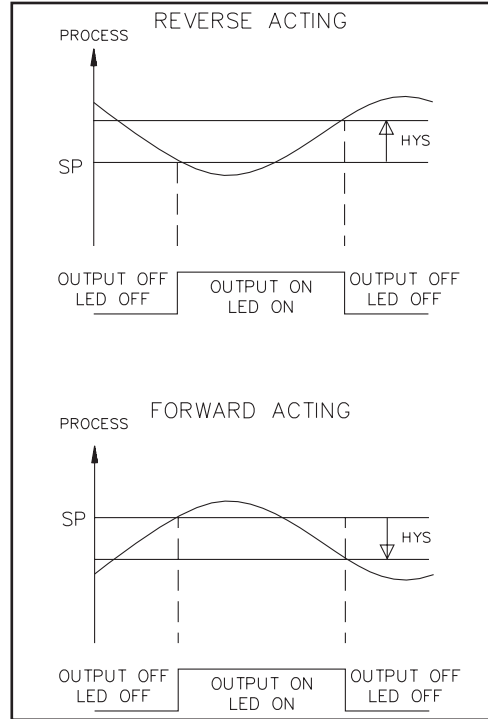

Figure 33, OP1 On/Off Action

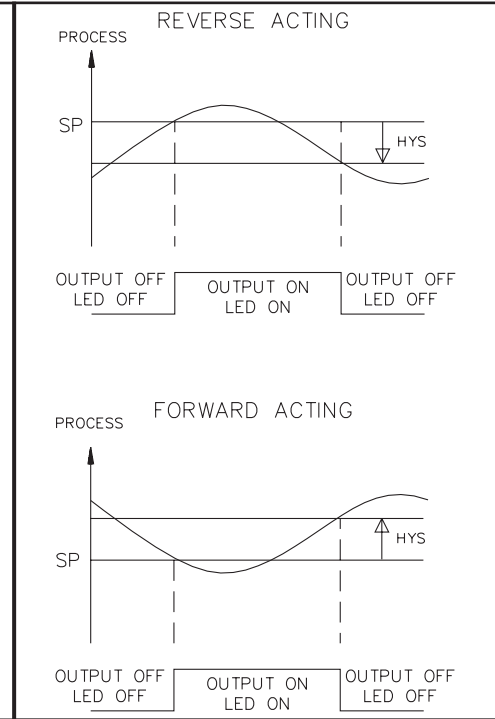

Figure 34, OP2 On/Off Action

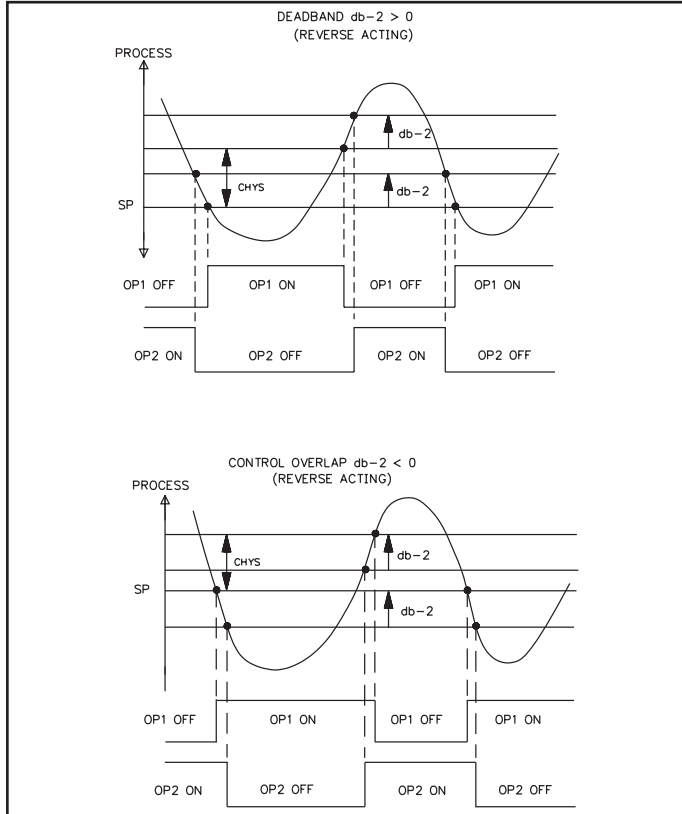

Figure 35, OP1/OP2 On/Off Action

ON/OFF and PID control can be used for the main output (OP1) and the secondary output (OP2) in several combinations.

The following lists the valid control modes:

OP1 & OP2 VALID CONTROL MODES				
OP1 MODE	OP2 MODE	MANUAL MODE OUTPUT POWER RANGE	OP1 STATE	OP2 STATE
PID	—	0% to +100%	OP1-TP	—
ON/OFF PrOP = 0.0	—	100	OP1-ON	—
		Any other setting	OP1-OFF	—
PID	PID	-100% to +100%	OP1-TP	OP2-TP
PID	ON/OFF (GAN2=0.0)	0% to +100%	OP1-TP	OP2-OFF
		-100% to 0%	OP1-TP	OP2-ON
ON/OFF (PrOP=0.0)	ON/OFF (GAN2=0.0)	+100%	OP1-ON	OP2-OFF
		-100%	OP1-OFF	OP2-ON
		Any other setting	OP1-OFF	OP2-OFF

TP - Time Proportioning
Note: In manual mode, the % output power is not limited to the output power limits (OPLO & OPHI).

AUTO-TUNE

Auto-Tune is a user initiated function in which the controller automatically determines the PID settings based upon the process characteristics. During Auto-Tune, the controller temporarily causes the system to oscillate by cycling the output power from 0 to 100%. The nature of these oscillations determines the settings of the controller's parameters.

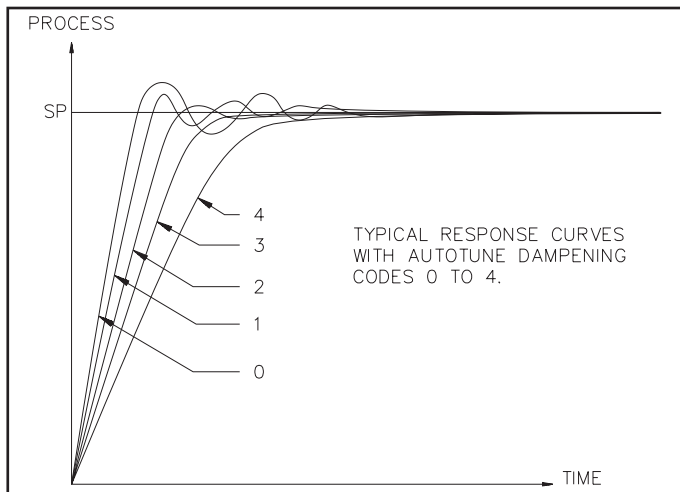

Figure 36, Dampening Code

Note: If the induced oscillations caused by Auto-Tune can cause system problems or are otherwise unacceptable, the Step Response Manual Tuning Procedure can be used as a tuning alternative.

Prior to initiating Auto-Tune, it is essential that the controller be configured to the application. In particular, control hysteresis (CHYS) and Auto-Tune dampening code (tcod) must be set in the Output Parameters section. Generally, control hysteresis of 2 to 5 units is adequate. The

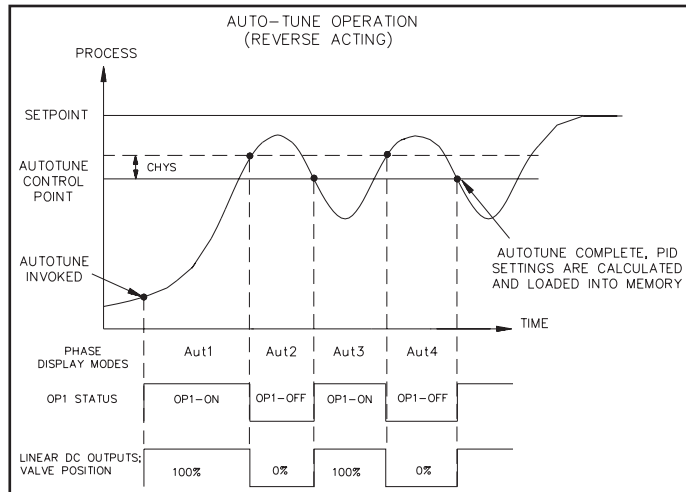

Figure 37, Auto-Tune Operation

dampening code may be set to yield the response characteristics shown in Figure 36, Dampening Code. A dampening code setting of zero gives the fastest response with possible overshoot, and a code of four gives the slowest response with minimum overshoot.

The following controller parameters are set by Auto-tune according to the characteristics of the process:

- Proportional Band (ProP)
- Integral Time (Intt)
- Derivative Time (dErt)
- Input Filter (Fltr)
- Output Power Dampening (OPdP)

As shown in Figure 37, Auto-Tune Operation, Auto-Tune cycles the process at a control point 3/4 of the distance between the current process signal value (at the instant Auto-Tune is started) and the setpoint. The 3/4 control point was selected to reduce the chance of signal overshoot at setpoint when Auto-Tuning at start-up. If Auto-Tuning from setpoint and signal overshoot is unacceptable, temporarily lower the setpoint by an amount of the oscillation and then Auto-Tune. Reset the setpoint to the original value when Auto-Tune is complete. After starting Auto-Tune, the secondary display indicates the current phase (Aut1, Aut2, Aut3 & Aut4). If the controller remains in an Auto-Tune phase unusually long, the process or connections may be faulty. Additionally, during Auto-Tune it is important that disturbances to the system be minimized, as these may have an effect on the parameter determination.

INITIATE AUTO-TUNE

Auto-Tune may be initiated at start-up, from setpoint, or at any other process signal point.

To Initiate Auto-Tune:

1. Make sure that Auto-Tuning is enabled in parameter lockouts module.
2. Place the controller into the normal display mode.
3. Press PAR for 3 seconds from normal display mode.
4. Scroll to "tUNE" by use of PAR, if necessary.
5. Select "YES" and press PAR.
Auto-Tune is initiated.

To Cancel Auto-Tune: (Old PID settings remain in effect).

- A) Make sure that Auto-Tuning is enabled in parameter lockouts module.
1. Place the controller into the normal display mode.
 2. Press PAR for 3 seconds from normal display mode.
 3. Scroll to "tUNE" by use of PAR, if necessary.
 4. Select "NO" and press PAR.
 5. Auto-Tune canceled.

- B) Or reset the controller by disconnecting AC power.

Note: If using the linear DC output for control, full power is applied (+100% OP1 or -100% OP2) regardless of the output power limit settings. Set the Linear DC Output scaling points to limit the magnitude of the output, if desired.

AUTO-TUNE OF SECONDARY OUTPUT (OP2) / MAIN OUTPUT (OP1) SYSTEMS

During Auto-Tune of OP2/OP1 systems, the controller switches the secondary output (OP2) on and off in addition to the main output (OP1). The deadband parameter (db-2) determines the amount of overlap or deadband between the two outputs during Auto-Tune. Refer to *ON/OFF CONTROL*, page 62, for the operation of this parameter. The deadband parameter remains unchanged after Auto-Tune is complete. Therefore, when proportional control is started after the completion of Auto-Tune, this parameter may need to be reset.

It is important that external load disturbances be minimized, and if present, other zone controllers idled as these may have an effect on the PID constant determination. The controller additionally sets the Relative Gain parameter (GAN2) for OP2/OP1 systems.

AUTO-TUNE OF INTERNAL CASCADE CONTROLLERS

Auto-Tune of Internal Cascade controllers involves tuning of the Primary PID and Secondary PID parameters. Each set of parameters is tuned individually with the secondary parameters normally tuned first. For Internal Cascade controllers, Auto-Tune offers the option of tuning the Primary or Secondary:

tunE

- | | | |
|-----|---|--|
| no | – | No Auto-Tune or abort Auto-Tune |
| Pri | – | Start Auto-Tune of primary or Auto-Tune of primary in progress |
| SEC | – | Start Auto-Tune of secondary or Auto-Tune of secondary in progress |

The Auto-Tune status display indicates the set of parameters actively Auto-Tuned:

TunePhase	Display (Primary)	Display (Secondary)
1	APr1	ASC1
2	APr2	ASC2
3	APr3	ASC3
4	APr4	ASC4

The following additional parameters are calculated and set as a result of Auto-Tuning of the secondary:

- Secondary Proportional Band (Pb-2)
- Secondary Integral Time (It-2)
- Secondary Derivative Time (dt-2)
- Secondary Output Power Dampening (OPd2)

Auto-Tuning of the secondary presents two different control points at which the controller cycles power. In Automatic mode of operation, the secondary control point is the setpoint directed by the primary at the instant Auto-Tune is started. In Manual mode of operation, the secondary control point is the secondary process value reading at the instant Auto-Tune is started. The secondary is normally Auto-Tuned with the controller in the Manual mode of operation unless the process is reasonably under control. Prior to tuning the Secondary, it is essential that it is scaled to match the actual secondary process range. This is important for proper Auto-Tuning of the primary. Subsequent changes made to scaling values may require re-tuning.

The following procedure may be used to initially tune an Internal Cascade controller:

- 1) Place the controller into Manual (USER) mode of operation.
- 2) Adjust output power level until primary variable is close to primary setpoint. ($\pm 10\%$ of range)
- 3) Auto-Tune the secondary.
- 4) Auto-Tune the primary.
- 5) Place controller into Automatic (Auto) mode of operation.
- 6) Initial tuning is complete.

After the process has stabilized, the primary and secondary may be re-tuned in Automatic mode of operation. Normally, the primary requires re-tuning whenever the secondary PID constants are changed.

AUTO-TUNE OF EXTERNAL CASCADE SYSTEMS (REMOTE SETPOINT)

External Cascade systems involve the use of two controllers, the Primary and the Secondary, that have a Remote Setpoint Input. In such a system, the Secondary controller is normally tuned first followed by tuning of the primary controller. Prior to tuning the Secondary controller, it is essential that the Remote Setpoint is scaled to match the actual secondary process range. This is important for proper Auto-Tuning of the primary controller. Subsequent changes made to scaling values may require re-tuning. The following procedure may be used to initially tune an External Cascade controller:

- 1) Place the Secondary controller into Local Setpoint mode and Manual (USER) mode of operation.
- 2) Adjust output power level of the secondary until primary variable is close to primary setpoint. ($\pm 10\%$ of range)
- 3) Key-in secondary setpoint value equal to secondary process value.
- 4) Auto-Tune the secondary controller while in Local Setpoint mode.
- 5) Place the secondary controller into Remote Setpoint mode and Automatic (Auto) mode of operation.
- 6) Auto-tune the primary controller while the primary is in Automatic mode of operation.
- 7) Initial tuning of system is complete.

After the process has stabilized, the primary and secondary may be re-tuned in Automatic mode of operation. Normally, the primary requires re-tuning whenever the secondary PID constants are changed.

Note: For Remote Setpoint controllers, the Auto-tune control point is derived from the Remote Setpoint when in Remote Setpoint mode and it is derived from the Local Setpoint when in Local Setpoint mode.

APPENDIX “A” - APPLICATION EXAMPLES

CHEMICAL MIXING APPLICATION

A customer wants to control the ratio of one liquid flow to the other in a chemical mixing application. Each flow is monitored with a flow transducer that provides a 4 to 20 mA output signal. The PCU monitors the flow of liquid “A” via the optional Remote Setpoint Input. Liquid “B” is monitored by the main input. Both inputs are scaled independently during initial setup and programming. The only task left to the operator is to enter the desired ratio of B to A.

The 4 to 20 mA output of the PCU controls the position of a proportional valve. Thus controlling the flow of B. As disturbances cause the flow of A to vary, the PCU ensures that the proper ratio is always maintained. The flow of “A” is shown in the secondary display simultaneously with the flow of “B”(main display).

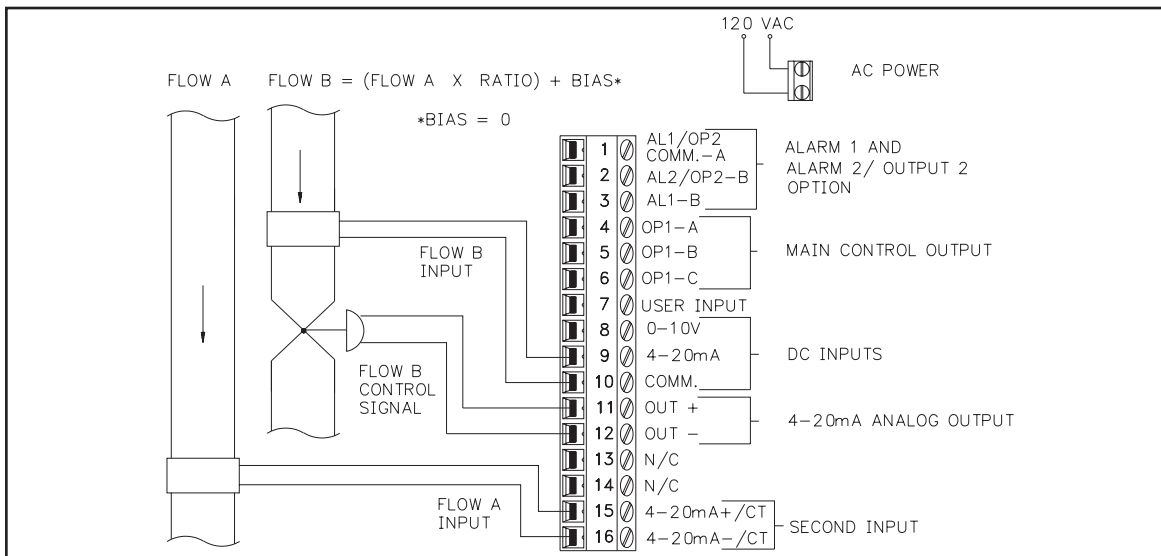

Figure 38, Chemical Mixing, Flow Ratio Application

FLOW RATE PROGRAMMING EXAMPLE

A plastics manufacturer needs to maintain a constant flow rate on a feed stock pipeline to insure their product stays within specification. A PCU is installed to maintain the flow by controlling a proportional control valve.

The output of the flow meter is 0 to 10 VDC. The control valve is positioned by an electric actuator that requires a 4 to 20 mA control signal.

The following is a list of the parameter values keyed-in to the controller.

Configure Input Parameters

TYPE	VOLT	Set input signal for voltage
dCpt	0.0	Scaled display to indicate in tenths
rnd	0.1	No rounding of the display
FLtr	1	Normal input signal filtering
dSP1	0.0	Display value for scaling point 1 is 0.0
INP1	0.00	Signal value for scaling point 1 is 0.00
dSP2	100.0	Display value for scaling point 2 is 100.0
INP2	10.00	Signal value for scaling point 2 is 10.00
SPLO	0.0	Limit min. setpoint value to 0.0 units
SPHI	110.0	Limit max. setpoint value to 110.0 units
SPrP	0.1	Setpoint ramp rate = 0.1 units/minute
INPt	trnF	Allow remote switching of auto/manual mode

Configure Output Parameters

CYct	0	Main control output and indicator off
OPAC	rEV	Main control output is reverse acting
OPLO	0	Limit min. controller power to 0%
OPHI	100	Limit max. controller power to 100%
OPFL	0	Controller output power to 0 if input overdrive signal is detected
OPdP	2.0	Output power dampening = 2.0
CHYS	0.1	Control hysteresis set for 0.1
tcod	0	Select fastest response
ANAS	OP	Linear DC output used for control
ANLO	0.0	Control valve provides full deflection for 4 to 20 mA signal range
ANHI	100.0	
Andb	2.5	Impose 2.5% deadband on Linear DC output
ANut	2	Update output once every 2 seconds

Configure Alarm Parameters

Act1	A-HI	Set alarm #1 for absolute high acting
rSt1	LAtC	Alarm set for latching
Stb1	YES	Disable alarm during power-up
AL-1	90.0	Set alarm value for 90.0
Act2	A-LO	Set alarm #2 for absolute low acting
rSt2	LAtC	Alarm set for latching
Stb2	YES	Disable alarm during power-up
AL-2	20.0	Set alarm value for 20.0
AHYS	0.1	Alarm activation hysteresis set for 0.1

APPENDIX "B" - SPECIFICATIONS AND DIMENSIONS

1. DISPLAY: Dual 4-digit

Upper Process Display: 0.4" (10.2 mm) high red LED

Lower Auxiliary Display: 0.3" (7.6 mm) high green LED

Display Messages (Model dependent):

- "OLOL" – Appears when measurement exceeds + 105% input range.
- "ULUL" – Appears when measurement exceeds - 5% input range.
- "SENS" – Appears when measurement exceeds \pm "OLOL" & "ULUL" range.
- "...." – Appears when display values exceed + display range.
- "...." – Appears when display values exceed - display range.
- "SLid" – Appears when loss of slidewire signal is detected.
- "VALV" – Appears when valve actuator error is detected.

2. POWER: Switch selectable 115/230 VAC (+10%, -15%) no observable line variation effect, 48-62 Hz, 10 VA.

3. ANNUNCIATORS:

LED Backlight Status Indicators (Model dependent):

- %PW – Lower auxiliary display shows power output in (%).
- DEV – Lower auxiliary display shows deviation (error) from setpoint.
- OP1 – Main control output is active.
- AL1 – Alarm #1 is active.
- AL2 – Alarm #2 is active (for Dual Alarm Option).
- OP2 – Secondary output is active (for Secondary Output Option).
- OPN – Valve positioner OPEN output is active (for Valve Positioner option).
- CLS – Valve positioner CLOSE output is active (for Valve Positioner option).
- SEC – Lower auxiliary display shows second analog input (for Second Analog Input option).
- MAN – Flashing: Controller is in Manual control mode.
- REM – ON: controller is in remote setpoint mode (Second Analog Input option).
– OFF: controller is in local setpoint mode (Second Analog Input option).
– Flashing: controller is in Manual control mode (Second Analog Input optional).

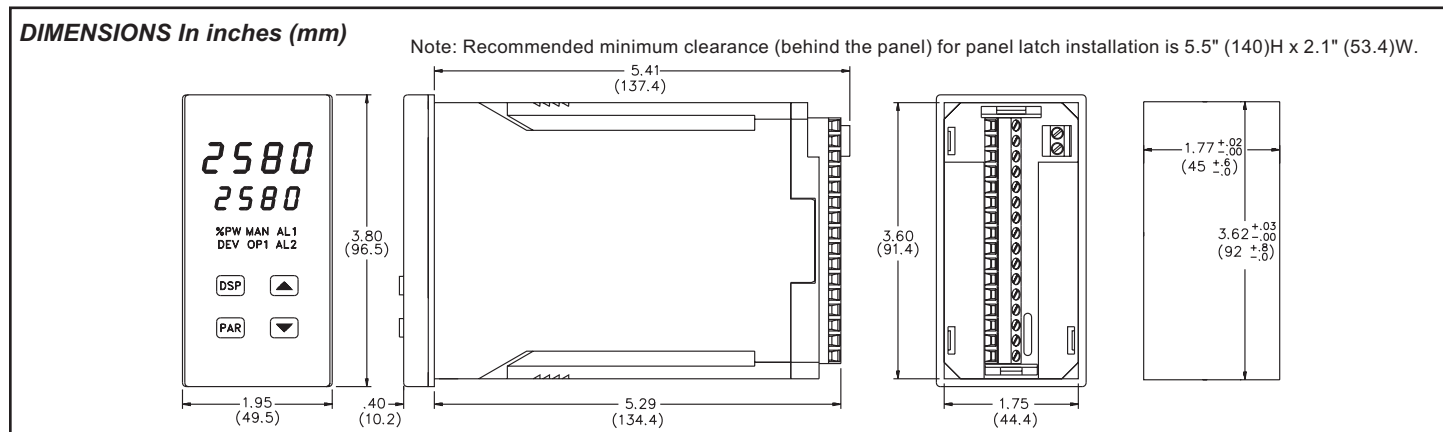

Figure 39, Dimensions

4. **CONTROLS:** Four front panel push buttons for modifying and setup of controller functions and one external input for parameter lockout or other functions.

5. **SIGNAL INPUT:**

Sample Period: 100 msec typ.

Response Time: 300 msec typ. (to within 99% of final value w/step input)

Signal Overdrive Threshold:

10 V Range: 13.00 V typ.

20 mA Range: 26.00 mA typ.

Signal Overdrive Response:

Main Control Output(s): Programmable preset output

Display: "SENS"

Alarms: Upscale drive

DC Linear: Programmable preset output

Normal Mode Rejection: 40 dB typ. @ 50/60 Hz (improves with increased digital filtering).

Common Mode Rejection: 100 dB typ., DC to 60 Hz

Protection: Input overload 120 VAC for 30 seconds.

Range and Accuracy:

Signal Range	Accuracy (% of Unscaled Reading)	Maximum Input	Input Impedance	Resolution
0-10 VDC	$\pm(0.15\% + 3 \text{ mV} + 1 \text{ LSD})$	300 VDC	1 M Ω	10 mV
0-20 mA DC	$\pm(0.15\% + 6 \mu\text{A} + 1 \text{ LSD})$	200 mA DC	10 Ω	10 μA

6. **OUTPUT MODULES [Optional] (For All Output Channels):**

Relay:

Type: Form-C (Form-A with some models. See Ordering Information)

Rating: 5 Amps @ 120/240 VAC or 28 VDC (resistive load), 1/8 HP @ 120 VAC max. (inductive load)

Life Expectancy: 100,000 cycles at max. load rating. (Decreasing load and/or increasing cycle time, increases life expectancy).

Logic/SSR Drive: Can drive multiple SSR Power Units.

Type: Non-isolated switched DC, 12 VDC typical

Drive: 45 mA maximum

Triac:

Type: Isolated, Zero Crossing Detection

Rating:

Voltage: 120 to 240 VAC

Max. Load Current: 1 Amp @ 35°C
0.75 Amp @ 50°C

Min. Load Current: 10 mA

Offstate Leakage Current: 7 mA max. @ 60 Hz

Operating Frequency: 20 to 400 Hz

Protection: Internal Transient Snubber, Fused

7. **MAIN CONTROL OUTPUT:**

Control: PID or ON/OFF

Output: Time proportioning or linear DC

Hardware: Plug-in, replaceable output modules

Cycle time: Programmable

Auto-tune: When selected, sets proportional band, integral time, and derivative time values.

Signal Overdrive Action: Programmable

8. **SECONDARY OUTPUT (Optional):**

Control: PID or ON/OFF

Output: Time proportioning or linear DC

Hardware: Plug-in, replaceable output modules

Cycle time: Programmable

Proportional Gain Adjust: Programmable

Deadband Overlap: Programmable

9. **LINEAR DC OUTPUT (Optional):** With digital scale and offset, programmable deadband and update time.

4 to 20 mA:

Resolution: 1 part in 3500 typ.

Accuracy: $\pm(0.1\%$ of reading + 25 $\mu\text{A})$

Compliance: 10 V (500 Ω max. loop impedance)

0 to 10 VDC:

Resolution: 1 part in 3500 typ.

Accuracy: $\pm(0.1\%$ of reading + 35 mV)

Min. Load Resistance: 10 K Ω (1 mA max.)

Source: % output power, setpoint, deviation, or process value (Available for OP1 or OP2, but not both.)

10. **MOTORIZED VALVE POSITIONER (Optional):**

Two Outputs: Valve open and valve close or Linear DC (optional)

Hardware: Plug-in, replaceable output modules

Three Inputs: Slidewire feedback, signal fail detect (Isolated from main input)

Slidewire resistance: 100 Ω to 100 K Ω

Slidewire exciting voltage: 0.9 VDC typ.

Slidewire fail action: programmable

Control mode: Position mode (with slidewire) and
Velocity mode (w/o slidewire)

Control deadband: 0.1% to 25.0% (position mode)
0.1 to 25.0 seconds (velocity mode)

Update time: 1 to 250 seconds

Motor time (open, close): 1 to 9999 seconds

Position limits: Adjustable 0.0 to 100.0% of valve stroke

Valve fail time: Off to 9999 seconds

Alarm mode: Dual acting; loss of slidewire feedback signal and valve fail
detection

11. SECOND ANALOG INPUT:

Range: 0-20 mA (Isolated from main input)

Overload: 100 mA_{MIN} (steady state)

Input Resistance: 10 Ω typ. Voltage drop (@ 20 mA); 0.2 V typ.

Accuracy: 0.15% of reading ±10 μA ± 1 LSD

Scale Range: -999 to 9999

12. SERIAL COMMUNICATION:

Type: RS485 Multi-point, Balanced Interface

Communication Format:

Baud Rate: Programmable from 300 to 9600

Parity: Programmable for odd, even, or no parity

Frame: 1 start bit, 7 data bits, 1 or no parity bit, 1 stop bit

Unit Address: Programmable from 0 to 99, max. of 32 units per line

Transmit Delay: 100 msec min., 200 msec max.

RS485 Common: Isolated from signal input common

Auto Print Time: Off to 9999 seconds between print-outs

13. USER INPUT (Optional): Internally pulled up to +5 VDC.

$V_{IN} = 5.25 V_{DC\ MAX}$; $V_{IL} = 0.85 V_{MAX}$; $V_{IH} = 3.0 V_{MIN}$

Available on all second input (MVP and ANA) models and on models with
RS485.

Response time: 100 msec max.

Functions:

Program Lock

Auto/Manual Mode Select

Setpoint Ramp Select

Print Request

Integral Action Lock

Reset Alarms

Local/Remote Setpoint Select

14. ALARMS (Optional):

Hardware: Plug-in, replaceable output module

Modes: Absolute high acting

Absolute low acting

Deviation high acting

Deviation low acting

Inside band acting

Outside band acting

Valve fail

Second Analog Input monitoring

Reset Action: Programmable; automatic or latched

Standby Mode: Programmable; enable or disable

Hysteresis: Programmable

Signal Overdrive Action: Upscale

Annunciator: LED backlight for “AL1”, “AL2”, (Alarm #2 not available
with secondary output or motorized valve position option.)

15. ENVIRONMENTAL CONDITIONS:

Operating Range: 0 to 50°C

Storage Range: -40 to 80°C

Span Drift (maximum): 100 ppm/°C, main input; 150 ppm/°C,
second input

Zero Drift (maximum):

4 to 20 mA DC Range: 0.5 μA/°C

0-10 VDC Range: 0.2 mV/°C

Second Input: 2 μA/°C

Relative Humidity: Less than 85% RH (non-condensing) from 0°C
to 50°C.

Altitude: Up to 2000 meters

16. ISOLATION BREAKDOWN RATINGS:

All inputs and outputs with respect to AC line: 2300 V_{MIN}

**Analog Output, Second Analog Input, or Slidewire Input with respect
to Main Input:** 500V_{MIN}

17. CERTIFICATIONS AND COMPLIANCES:

SAFETY

UL Listed, File #E137808, UL508, CSA C22.2 No. 14-M95
LISTED by Und. Lab. Inc. to U.S. and Canadian safety standards
UL Recognized Component, File #E156876, UL873, CSA C22.2 No. 24
Recognized to U.S. and Canadian requirements under the Component
Recognition Program of Underwriters Laboratories, Inc.
Type 2 or 4X Enclosure rating (Face only), UL50
IECEE CB Scheme Test Certificate #UL1239-156876/USA,
CB Scheme Test Report #96ME50279-070794
Issued by Underwriters Laboratories, Inc.
IEC 1010-1, EN 61010-1: Safety requirements for electrical
equipment for measurement, control, and laboratory use, Part 1.
IP65 Enclosure rating (Face only), IEC 529

ELECTROMAGNETIC COMPATIBILITY

Immunity to EN 50082-2

Electrostatic discharge	EN 61000-4-2	Level 2; 4 Kv contact Level 3; 8 Kv air
Electromagnetic RF fields	EN 61000-4-3	Level 3; 10 V/m ¹ 80 MHz - 1 GHz
Fast transients (burst)	EN 61000-4-4	Level 4; 2 Kv I/O Level 3; 2 Kv power
RF conducted interference	EN 61000-4-6	Level 3; 10 V/rms ² 150 KHz - 80 MHz

Emissions to EN 50081-2

RF interference	EN 55011	Enclosure class A Power mains class A
-----------------	----------	--

Notes:

1. *Self-recoverable loss of performance during EMI disturbance at 10 V/m:
Measurement input and/or analog output signal may deviate during
EMI disturbance.*
*For operation without loss of performance:
Install power line filter, RLC #LFIL0000 or equivalent.*

2. *Self-recoverable loss of performance during EMI disturbance at 10 Vrms:
Measurement input and/or analog output signal may deviate during
EMI disturbance.*

For operation without loss of performance:

Install power line filter, RLC #LFIL0000 or equivalent.

*Refer to the EMC Installation Guidelines section of the manual for additional
information.*

18. **CONNECTION:** Jaw-type terminal block

Wire Range: 12-30 AWG copper wire

Torque: 5-7 inch-lbs (56-79 N-cm)

19. **CONSTRUCTION:** NEMA 2 for standard models.

Front Panel: Flame and scratch resistant tinted plastic

Case: High impact black plastic. (Mounting collar included)

NEMA 4X/IP65 model only: Sealed bezel utilizing two captive mounting
screws (panel gasket included) This unit is rated for NEMA 4X/IP65
indoor use. Installation Category II, Pollution Degree 2.

20. **WEIGHT:** 1.3 lbs (0.6 kgs)

APPENDIX “C” - TROUBLESHOOTING

The majority of problems can be traced to improper connections or incorrect set-up parameters. Be sure all connections are clean and tight, that the correct output module is fitted, and that the set-up parameters are correct. For further technical assistance, contact technical support at the numbers listed on the back cover of the instruction manual.

PROBLEMS	POSSIBLE CAUSE	REMEDIES
NO DISPLAY	<ol style="list-style-type: none"> 1. Power off 2. Voltage selector switch in the wrong position. 3. Brown out condition. 4. Loose connection or improperly wired. 5. Bezel assembly not fully seated into rear of unit. 	<ol style="list-style-type: none"> 1. Check power. 2. Check selector switch position. 3. Verify power reading. 4. Check connections. 5. Check installation.
INDICATOR NOT WORKING	<ol style="list-style-type: none"> 1. Incorrect parameter set-up. 	<ol style="list-style-type: none"> 1. Check set-up parameters. <ol style="list-style-type: none"> a. Power-up unit for self-test.
“E-FP” IN DISPLAY	<ol style="list-style-type: none"> 1. Defective front panel button. 	<ol style="list-style-type: none"> 1. Press DSP to escape, then check all buttons for proper operation. 2. Replace unit
“E-UP” IN DISPLAY	<ol style="list-style-type: none"> 1. Internal problem with controller. 	<ol style="list-style-type: none"> 1. Replace unit
“E-E2” IN DISPLAY	<ol style="list-style-type: none"> 1. Loss of set-up parameters due to noise spike. 	<ol style="list-style-type: none"> 1. Press DSP to clear, then check all set-up parameters. <ol style="list-style-type: none"> a. Check input and AC line for excessive noise. b. If fault persists, replace unit.
“...” OR “-...” IN DISPLAY	<ol style="list-style-type: none"> 1. Input display out of range. 2. Loss of set-up parameters. 3. Internal malfunction. 	<ol style="list-style-type: none"> 1. Check unit scaling. 2. Check set-up parameters. 3. Check calibration.
“SENS” IN DISPLAY	<ol style="list-style-type: none"> 1. Incorrect input wiring. 2. Defective transmitter. 3. Internal malfunction. 	<ol style="list-style-type: none"> 1. Check input wiring. 2. Check signal calibration. 3. Check calibration.
“OLOL” IN DISPLAY	<ol style="list-style-type: none"> 1. Input signal overload. 2. Loss of set-up parameters. 	<ol style="list-style-type: none"> 1. Check input signal set-up. 2. Check set-up parameters.
“ULUL” IN DISPLAY	<ol style="list-style-type: none"> 1. Input signal overload. 2. Loss of set-up parameters. 	<ol style="list-style-type: none"> 1. Check input signal set-up. 2. Check set-up parameters.

APPENDIX “C” - TROUBLESHOOTING (Cont’d)

PROBLEMS	POSSIBLE CAUSE	REMEDIES
“VALV” IN DISPLAY Valve Fail Alarm	<ol style="list-style-type: none"> 1. Valve or valve motor jammed. 2. Loss of power to valve motor. 3. Slidewire feedback signal lost. 	<ol style="list-style-type: none"> 1. Check valve or valve motor for operation. 2. Check power to valve motor. 3. Increase valve fail time.
“SLId” IN DISPLAY	<ol style="list-style-type: none"> 1. Slidewire feedback signal lost. 	<ol style="list-style-type: none"> 1. Check slidewire feedback signal.
DISPLAY INCORRECT OR DISPLAY WANDERS	<ol style="list-style-type: none"> 1. Loose or corroded connections. 2. Signal source in noisy environment. 3. Controller needs calibration. 	<ol style="list-style-type: none"> 1. Check connections. 2. Evaluate signal source location. <ol style="list-style-type: none"> a. Increase digital input filtering. 3. Check calibration.
PROCESS SLUGGISH OR NOT STABLE	<ol style="list-style-type: none"> 1. Incorrect PID values. 	<ol style="list-style-type: none"> 1. See PID Control.
EXCESSIVE VALVE ACTIVITY OR HUNTING	<ol style="list-style-type: none"> 1. Insufficient valve control deadband. 2. Insufficient output dampening. 3. Incorrect PID values. 4. Valve update time too short. 	<ol style="list-style-type: none"> 1. Increase valve deadband. 2. Increase output dampening. 3. See PID Control. 4. Increase valve update time.
OUTPUTS NOT WORKING	<ol style="list-style-type: none"> 1. Output module not installed. 2. Improperly wired. 3. Incorrect output module. 4. Defective output module. 	<ol style="list-style-type: none"> 1. Install output module. 2. Check wiring. 3. Check output module. 4. Check or replace output module.
LINEAR DC OUTPUT NOT WORKING	<ol style="list-style-type: none"> 1. Improper load resistance. 2. Incorrect programming or scaling. 3. Connections reversed. 4. DC voltage source in loop (4 to 20 mA only). 	<ol style="list-style-type: none"> 1. Check load resistance. 2. Check programming. 3. Check connections. 4. This is an active loop. Remove all DC voltage sources (4 to 20 mA only).
CONTROLLER LOCKS UP OR RESETS	<ol style="list-style-type: none"> 1. Noise spikes entering controller due to load switching transients. 2. Defective controller. 	<ol style="list-style-type: none"> 1. Use RC snubber across the load. <ol style="list-style-type: none"> a. Use Triac output modules whenever possible. b. Use separate AC feed line to controller. c. Locate controller & signal lines away from noise producing mechanisms (solenoids, transformers, etc). 2. Replace Unit.

OUTPUT LEAKAGE CURRENT

The AL1 and AL2/OP2 outputs of the PCU have an RC Network (Snubber) on the Normally Open contacts. High energy noise spikes are generated whenever current through an inductive load (such as motors, solenoids or relay coils) is interrupted. This noise may interfere with the unit doing the switching and other nearby equipment causing erratic operation and accelerate relay contact wear.

The Snubber Network is specifically designed with a capacitor and resistor connected in series and installed across relay contacts. The network will have a small amount of AC leakage current even when the PCU's Relay Module is "off". The leakage current is 2.1 mA nominal at a line voltage of 120 VAC, and 4.3 mA nominal at 240 VAC respectively. Leakage current may cause some loads to stay on or to turn on when the Relay Module is turned off. This would only occur in unusual applications (such as with a relay with unusually low holding current or an LED). The leakage current may be eliminated by disabling the snubber, however, doing so will degrade the EMC performance of the unit.

First determine which output is associated with the leakage current: either AL1 or AL2/OP2. Remove the Bezel Assembly from the case (see *Removing Bezel Assembly*, page 5). The snubbers are located on the Option PCB (on the right side of the unit when viewed from the front). The snubbers consist of a capacitor and a resistor. The two resistors are located along the upper rear edge of the Option PCB. They are green in color and have color code stripes of yellow, violet, black and gold. There will be markings on the PCB close to the resistors that say "SNUB1" and "SNUB2" for AL1 and AL2/OP2 respectively. Using a pair of diagonal cutters, cut both leads of the appropriate resistor and remove it from the unit. Be sure to remove the resistor for only the problem alarm channel; leave the other channel's snubber functional in case it is needed.

The above stated leakage currents are valid when using the Relay Module (OMD00000). The Triac Module (OMD00001) has its own built in snubber and will introduce additional leakage current into the circuit. The Triac Module has leakage current of 2.1 mA nominal at a line voltage of 120 VAC, and 4.3 mA nominal at 240 VAC.

Note: The Snubber Network will be in one of the two configurations shown at right, depending on model ordered.

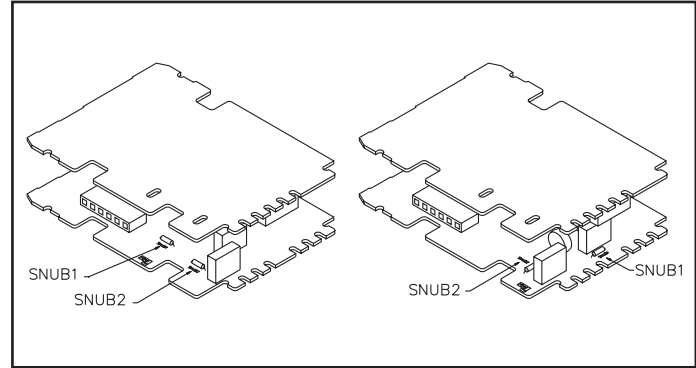

Figure 40, Snubber Locations

APPENDIX “D” - MANUAL TUNING

OPEN LOOP STEP RESPONSE METHOD

The Open Loop Step Response Method is a tuning procedure that does not induce process oscillations. This method involves making a step change to the process and observing the process reaction. A strip paper recorder or other high resolution data logging equipment is required for this procedure. This procedure requires that all disturbances to the process are minimized because the data is influenced by these disturbances.

- 1) Connect a chart recorder to log the process value and set the paper speed appropriate for the process.
- 2) Set the controller to manual (user) control mode.
- 3) Allow the process to stabilize (line out).
- 4) Make a step change of 10% or more in the controller output. It may be necessary to increase the size of the step to yield a sufficient process reaction curve.
- 5) Record the response of the process. Use the information from the table to calculate the controller tuning values. The PID tuning parameters are determined graphically from Figure 41, Process Reaction Curve. Draw a vertical line at the moment the step change was made. Draw a line (labeled tangent) through the process reaction curve at its maximum upward slope. Extend this line to intersect the vertical line. The time from the step change to this intersection is the process time constant, t . The slope of the tangent line is the process gain, a .

Example: From the Process reaction Curve
 $a = 30$, $t = 300$ sec, step = 10%, display range = 0 to 1000.

For fast response:

Prop = 60.0%
 Intt = 900 sec
 dert = 120 sec
 OPdP = 15

Parameter	Fast Response	Damped Response	Slow Response
Proportional Band (%)	$\frac{20000a}{\text{Range} \times \text{Step\%}}$	$\frac{40000a}{\text{Range} \times \text{Step\%}}$	$\frac{60000a}{\text{Range} \times \text{Step\%}}$
Integral Time (Sec)	$3t$	$4t$	$5t$
Derivative Time (Sec)	$0.4t$	$0.4t$	$0.4t$
Output Power Dampening (Sec)	$t/20$	$t/15$	$t/10$

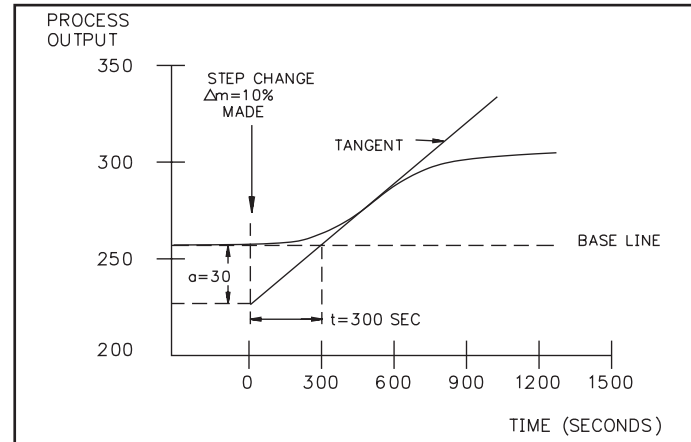

Figure 41, Process Reaction Curve

CLOSED LOOP CYCLING METHOD

An alternative to auto-tuning is manual tuning. This tuning method induces oscillations into the process in the same way as the controller's auto-tune function. If oscillations are not acceptable, the open-loop tuning method can be used.

The following is a manual tuning procedure for determination of the PID control constants.

1. Connect a chart recorder to log process value and set the paper speed appropriate for the process.
2. Set the controller to automatic (auto) control mode.
3. Set proportional band to 999.9%. (maximum setting)
4. Set integral time and derivative time to 0 seconds.
5. Decrease proportional band (increase controller gain) by factors of two until process just begins to oscillate and the oscillations are sustained. Make a small change in setpoint to provide a stimulus for oscillations. Allow adequate time for the process to respond. If oscillations appear to grow, increase proportional band. Adjust the proportional band until steady oscillations appear.
6. Note the peak-to-peak amplitude of the cycle (a) in degrees and the period of oscillation (t) in seconds.

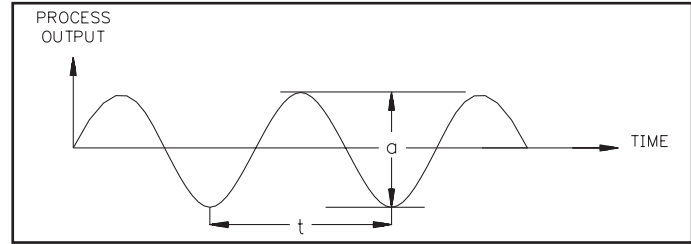

Figure 42, Closed Loop Tuning

Parameter	Fast Response	Damped Response	Slow Response
Proportional Band (%)	200a/range	400a/range	600a/range
Integral Time (sec)	1t	2t	3t
Derivative Time (sec)	0.2t	0.25t	0.25t
Output Power Dampening (sec)	t/40	t/30	t/20

APPENDIX “E” - CALIBRATION

CALIBRATION CHECK

The instrument has been fully calibrated at the factory for the voltage and current inputs. If the unit appears to be indicating or controlling incorrectly, see *Troubleshooting*, page 73, before attempting this procedure.

If the controller is suspected of reading incorrectly, the instrument may be checked for indication accuracy without disturbing the factory calibration. The parameters to be checked are: voltage reading, mA reading, linear DC output, Second Input, and Valve Position Feedback. The following procedures may be used for this purpose.

Note: Allow 1/2 hour warm-up with the controller in an upright position to allow adequate ventilation to the case before checking these parameters.

VOLTAGE READING CHECK

1. Connect a DC volt source with an accuracy of 0.01% or better to terminal #8 (+) and terminal #10 (-).
2. Advance to the configuration parameter modules from the normal display mode.
3. Set the controller to indicate voltage (VOLT), in the input parameter module.
4. Press the “PAR” key until “INP 1” appears in the main display.
5. Press the “DSP” key, once, the “%PW” & “DEV” annunciators will flash.
6. The secondary display will indicate voltage applied at Terminals 8 & 10.
7. Compare the controller read-out to the standard at various points over the range (0-10 V). The tolerance is 0.15% of reading ± 1 LSD.
8. Calibrate the controller if the readings are out of tolerance.

CURRENT READING CHECK

1. Connect a current source with an accuracy of 0.01% or better to terminal #9 (+) and terminal #10 (-).
2. Advance to the configuration parameter modules from the normal display mode.
3. Set the controller to indicate current (Curr), in the input parameter module.
4. Press the “PAR” key until “INP 1” appears in the main display.
5. Press the “DSP” key, once, the “%PW” & “DEV” annunciators will flash.
6. The secondary display will indicate the current applied at Terminals 9 & 10.
7. Compare the controller read-out to the standard at various points over the range (4 to 20 mA). The tolerance is 0.15% of reading ± 1 LSD.
8. Calibrate the controller if the readings are out of tolerance.

LINEAR DC OUTPUT CHECK

4 to 20 mA

1. Connect an ammeter to the linear output (#11 & #12) with an accuracy of 0.1% or better.
2. Set “ANAS” (Analog Assignment) to “INP”, in Configure Input Parameters.
3. Drive the input signal level below the programmed “ANLO” value. Check for 4 mA (± 0.02 mA).
4. Drive the input signal level above the programmed “ANHI” value. Check for 20 mA (± 0.03 mA).
5. Calibrate the controller linear DC output if out of tolerance.

0 to 10 VDC

1. Connect a voltmeter to the linear output (#11 & #12).
2. Set “ANAS” (Analog Assignment) to “INP”, in Configure Input Parameters.
3. Drive the input signal level below the programmed “ANLO” value. Check for 0 VDC (± 20 mV).
4. Drive the input signal level above the programmed “ANHI” value. Check for 10 VDC (± 30 mV).
5. Calibrate the controller linear DC output if out of tolerance.

SECOND INPUT CHECK

The Second Input Check applies to those models that have the Second Analog Input (Remote Setpoint) and Valve Positioner options. Different signals are required for each option.

Second Analog Input Check

1. Apply signals over the range of 0 to 20 mA DC to the terminals labeled Second Input, 4-20 mA+ and 4-20 mA-. The tolerance is 0.2% of full scale ± 1 LSD.
2. Calibrate the Second Analog Input if out of tolerance.

Valve Positioner Check

1. Apply signals derived from the resistor string as described in Valve Positioner Calibration. The tolerance is 0.2% of full scale ± 1 LSD.
2. Calibrate the Second Analog Input if out of tolerance.

CALIBRATION

When re-calibration is required (generally every two years), this procedure should be performed by qualified technicians using appropriate equipment. Equipment source accuracy of 0.01% or better is required.

The procedure consists of: applying accurate voltage signals, applying precision mA current and measuring accurate mA currents, among others. Allow a 30 minute warm-up period before starting this procedure.

This procedure may be aborted by disconnecting power to the controller before exiting the configuration mode. The existing calibration settings remain in affect.

Configure Step 9 - Factory Service Operations (9-Fs)

Display	Parameter		Description/Comments
Code	Enter factory service function code	48	Calibrate instrument
CAL	Voltage and Current Calibration	yes/no	Calibration of voltage input is done first.
ANCL	Analog Output Calibration	yes/no	This parameter will not appear if analog output option is not installed.
2CAL	Second Analog Input Calibration	yes/no	This parameter will not appear if second analog input is not installed.

Voltage Calibration

Connect precision voltage source with an accuracy of 0.01% to terminals (+) #8 and (-) #10 for voltage calibration.

Display	Parameter	Description/Comments
StP1	0.000 V step	Apply 0.000 V, wait 10 seconds, press PAR.
StP2	1.667 V step	Apply 1.667 V, wait 10 seconds, press PAR.
StP3	3.333 V step	Apply 3.333 V, wait 10 seconds, press PAR.
StP4	5.000 V step	Apply 5.000 V, wait 10 seconds, press PAR.
StP5	6.667 V step	Apply 6.667 V, wait 10 seconds, press PAR.
StP6	8.333 V step	Apply 8.333 V, Wait 10 seconds, press PAR.
StP7	10.000 V step	Apply 10.000 V, wait 10 seconds, press PAR.
StP-	Pause	The controller imposes a 5 sec. delay (Keep the 10.000 V signal applied). The unit automatically advances to StPA.

Current Calibration

Connect a precision current source with an accuracy of 0.01% to terminals (+) #9 and (-) #10 for current calibration when step A appears.

Display	Parameter	Description/Comments
StPA	0.000 mA	Apply 0.000 mA, wait 10 seconds, press PAR.
StPB	20.000 mA	Apply 20.000 mA, wait 10 seconds, press PAR.
		The unit automatically advances to analog output calibration if the option is installed.

Analog Output Calibration (ANCL)

4 to 20 mA

Press PAR until “ANCL” appears in the display. Connect precision ammeter (0.1% accuracy) to rear terminals (+) #11 and (-) #12.

Display	Parameter	Description/Comments
ANC1	Analog output 4 mA code value	Observe current reading. If 4.00 mA, press PAR. If not equal, modify existing code value using up and down buttons to achieve 4.00 mA. Press PAR.
ANC2	Analog output 20 mA code value	Observe current reading. If 20.00 mA, Press PAR. If not equal, modify existing code value using up and down buttons to achieve 20.00 mA. Press PAR.

0 to 10 VDC

Press PAR until “ANCL” appears in the display. Connect a precision voltmeter (0.1% accuracy) to rear terminals (+) #11 and (-) #12.

Display	Parameter	Description/Comments
ANC1	Analog output 0 VDC code value	Observe voltage reading. If 0.00 VDC, press PAR. If not equal, modify existing code value using up and down buttons to achieve 0.00 VDC. Press PAR.
ANC2	Analog output 10 VDC code value	Observe voltage reading. If 10.00 VDC, Press PAR. If not equal, modify existing code value using up and down buttons to achieve 10.00 VDC. Press PAR.

Second Analog Input Calibration (2CAL)

The signals applied to the Second Analog Input for calibration depend on the type of model. Second Analog Input and Motorized Valve Positioner represent the models for which unique calibration signals are required.

Second Analog Input (Remote Setpoint)

Connect precision DC milliampere source (0.01% accuracy) to rear terminals labeled Second Analog Input, 4 to 20 mA+ and 4 to 20 mA-.

Display	Parameter	Description/Comments
StP1	0.00 mA step	Apply 0.00 mA DC, press PAR.
StP2	5.00 mA step	Apply 5.00 mA DC, press PAR.
StP3	10.00 mA step	Apply 10.00 mA DC, press PAR.
StP4	15.00 mA step	Apply 15.00 mA DC, press PAR.
StP5	20.00 mA step	Apply 20.00 mA DC, press PAR.

Motorized Valve Positioner

Construct a precision resistor divider network consisting of four 250Ω 0.1% tolerance resistors connected in series as shown in Figure 43, Resistor Divider. Connect one end of the resistor string to the rear terminal labeled Slidewire Feedback Inputs, Comm. and the other end to Excitation. The connection to the Wiper terminal comes from different points of the resistor string.

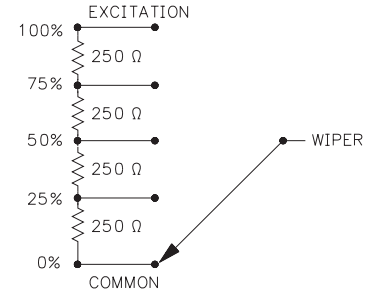

Figure 43, Resistor Divider

Display	Parameter	Description/Comments
StP1	0.0% step	Connect wiper input to 0% point of divider (Comm.), wait 10 seconds, press PAR.
StP2	25.0% step	Connect wiper input to 25% point of divider, wait 10 seconds, press PAR.
StP3	50.0% step	Connect wiper input to 50% point of divider, wait 10 seconds, press PAR.
StP4	75.0% step	Connect wiper input to 75% point of divider, wait 10 seconds, press PAR.
StP5	100.0% step	Connect wiper input to 100% point of divider (Excitation), wait 10 seconds press PAR.

APPENDIX "F"-USER PARAMETER VALUE CHART

UNIT NUMBER _____

MNEMONIC	PARAMETER	USER SETTING
SP	Setpoint	_____
OPOF	Output Power Offset	_____
OP	Output Power	_____
ProP	Proportional Band	_____
Intt	Integral Time	_____
dErt	Derivative Time	_____
SP-2	Internal Cascade Directed Setpoint	_____
Pb-2	Proportional Band #2 (secondary)	_____
It-2	Integral Time #2 (secondary)	_____
dt-2	Derivative Time #2 (secondary)	_____
rtio	Remote Setpoint Ratio	_____
BIAS	Remote Setpoint Bias	_____
AL-1	Alarm 1	_____
AL-2	Alarm 2	_____

CONFIGURE OUTPUT

MNEMONIC	PARAMETER	USER SETTING
CYct	Cycle Time	_____
OPAC	Control Action	_____
OPLO	Output Power Lower Limit Range	_____
OPHI	Output Power Upper Limit Range	_____
OPFL	Input Overdrive Power Preset	_____
OPdP	Output Power Dampening	_____
CHYS	ON/OFF Control Hysteresis	_____
tcod	Auto-Tune Dampening Code	_____
ANAS	Linear Output Assignment	_____
ANLO	Linear Output Scale Value	_____
ANHI	Linear Output Scale Value	_____
ANdb	Linear Output Deadband	_____
ANut	Linear Output Update Time	_____

CONFIGURE INPUT

MNEMONIC	PARAMETER	USER SETTING
tYPE	Input Type	_____
dCPt	Decimal Point	_____
root	Square Root Linearizing	_____
rnd	Rounding Increment	_____
FLtr	Digital Filtering	_____
dSP1	Display Value 1	_____
INP1	Signal Input Value 1	_____
dSP2	Display Value 2	_____
INP2	Signal Input Value 2	_____
SPLO	Setpoint Lower Limit	_____
SPHI	Setpoint Upper Limit	_____
SPrP	Ramp Rate	_____
InPt	User Input	_____

CONFIGURE LOCKOUTS

MNEMONIC	PARAMETER	USER SETTING
SP	Access Setpoint	_____
OP	Access Output Power	_____
dEv	Access Deviation Display	_____
IN-2	Access Second Analog Input Display	_____
bdSP	Access Blank Display	_____
Code	Access Code Number	_____
PID	Access Primary PID Values	_____
PID2	Access Secondary PID Values	_____
rtbs	Access Ratio and Bias Values	_____
AL	Access Alarm(s) Values	_____
ALrS	Enable Reset Alarm(s)	_____
SPSL	Enable Local/Remote Setpoint Selection	_____
trnF	Enable Auto/Man Transfer	_____
tUNE	Enable Auto-tune	_____

CONFIGURE ALARMS

MNEMONIC	PARAMETER	USER SETTING
Act1	Alarm 1 Operation Mode	_____
rSt1	Alarm 1 Reset Mode	_____
Stb1	Alarm 1 Standby Enabled	_____
AL-1	Alarm 1 Value	_____
Act2	Alarm 2 Operation Mode	_____
rSt2	Alarm 2 Reset Mode	_____
Stb2	Alarm 2 Standby Enabled	_____
AL-2	Alarm 2 Value	_____
AHYS	Alarm Hysteresis Value	_____

CONFIGURE SECONDARY OUTPUT

MNEMONIC	PARAMETER	USER SETTING
CYC2	OP2 Output Cycle Time	_____
GAN2	Relative Gain	_____
db-2	Overlap/Deadband	_____

CONFIGURE SERIAL COMMUNICATIONS

MNEMONIC	PARAMETER	USER SETTING
bAUd	Baud Rate	_____
PARb	Parity Bit	_____
Addr	Unit Address	_____
Abv	Abbrev. or Full Transmission	_____
PrAt	Automatic Print Rate	_____
PoPt	Print Options	_____
	INP	_____
	SEt	_____
	OPr	_____
	Pbd	_____
	INt	_____
	dEr	_____
	AL1	_____
	AL2	_____
	dEv	_____
	OFp	_____
	r_P	_____
	CrG	_____
	Cdb	_____
	OSt	_____
	rAt	_____
	bIA	_____
	RSP	_____
	IN2	_____
	Pb2	_____
	It2	_____
	dt2	_____
	SP2	_____

CONFIGURE SECOND ANALOG INPUT

MNEMONIC	PARAMETER	USER SETTING
OPER	Second Input Operating Mode	_____
root	Second Input Square Root Linearization	_____
dPt2	Second Input Decimal Point Position	_____
dSP1	Second Input, Display Scale Point 1	_____
INP1	Second Input, Input Scale Point 1	_____
dSP2	Second Input, Display Scale Point 2	_____
INP2	Second Input, Input Scale Point 2	_____
SPtr	Local/Remote Setpoint Select Action	_____
OPd2	Secondary PID Output Power Dampening	_____

CONFIGURE VALVE POSITIONER

MNEMONIC	PARAMETER	USER SETTING
VPS1	Valve Positioner Scale Point 1	_____
VPS2	Valve Positioner Scale Point 2	_____
VUdt	Valve Positioner Update Time	_____
VPdb	Valve Positioner Deadband	_____
VFAL	Valve Positioner Fail Time Alarm	_____
VOPt	Valve Positioner Motor Open Transit Time	_____
VCLt	Valve Positioner Motor Close Transit Time	_____
VONT	Valve Positioner Minimum On Time	_____

CONTROLLER OPERATING MODE

Local or Remote Setpoint _____
Automatic or Manual _____
Auto-tune Invoked at _____

APPENDIX “G” ORDERING INFORMATION

MODELS WITHOUT SECOND INPUT OPTIONS

NEMA 4X/IP65 BEZEL	4 to 20 mA ANALOG OUTPUT	0 to 10 VDC ANALOG OUTPUT	ALARM OUTPUTS	SECONDARY OUTPUT	RS485	PART NUMBER 115/230 VAC
NO	YES	NO	NO	NO	NO	PCU01000
NO	YES	NO	2	NO	NO	PCU01001
YES	NO	NO	NO	NO	NO	PCU10000
YES	NO	NO	2	NO	NO	PCU10001
YES	NO	NO	1	YES	NO	PCU10002
YES	YES	NO	NO	NO	NO	PCU11000
YES	YES	NO	2	NO	NO	PCU11001
YES	YES	NO	1	YES	NO	PCU11002
YES	YES	NO	2	NO	YES	PCU11004
YES	YES	NO	1	YES	YES	PCU11005
YES	NO	YES	2	NO	NO	PCU12001
YES	NO	YES	2	NO	YES	PCU12004
YES	NO	YES	1	YES	YES	PCU12005

These models have dual alarm outputs, or single alarm with secondary outputs, with shared common terminals (Form A Type). As a result, these outputs should be fitted with the same type of output module. The main output(OP1) may be fitted with any type of output module.

SECOND ANALOG INPUT MODELS (ANA)

NEMA 4X/IP65 BEZEL	4 to 20 mA ANALOG OUTPUT	0 to 10 VDC ANALOG OUTPUT	ALARM OUTPUTS	SECONDARY OUTPUT	RS485	PART NUMBER 115/230 VAC
YES	NO	NO	2	NO	YES	PCU10104
YES	YES	NO	2	NO	NO	PCU11108
YES	NO	YES	2	NO	NO	PCU12108

These models have dual alarm outputs, or single alarm with secondary outputs, with shared common terminals (Form A Type). As a result, these outputs should be fitted with the same type of output module. The main output (OP1) may be fitted with any type of output module.

MOTORIZED VALVE POSITIONER MODELS (MVP)

NEMA 4X/IP65 BEZEL	4 to 20 mA ANALOG OUTPUT	0 to 10 VDC ANALOG OUTPUT	ALARM OUTPUTS	SECONDARY OUTPUT	RS485	PART NUMBER 115/230 VAC
YES	NO	NO	1	NO	YES	PCU10307
YES	YES	NO	1	NO	NO	PCU11306
YES	NO	YES	1	NO	NO	PCU12306

ACCESSORIES

DESCRIPTION	PART NUMBER
Relay Module	OMD00000
Triac Module	OMD00001
Logic/SSR Drive Module	OMD00003
SSR Power Unit	RLY50000
Single Phase 25 A DIN Rail Mount Solid State Relay	RLY60000
Single Phase 40 A DIN Rail Mount Solid State Relay	RLY6A000
Three Phase DIN Rail Mount Solid State Relay	RLY70000

Note: Output Modules are NOT supplied with the controller. When specifying the controller, be sure to purchase the appropriate output module for the Main Control Output and if necessary, the alarm output(s), the secondary output, and valve positioner outputs.

The Logic/SSR Drive Module is a switched DC source, intended to drive the DC input of an SSR power unit. It should never be connected to line voltage.

All modules are packaged separately and must be installed by the user.

This page intentionally left blank.

LIMITED WARRANTY

The Company warrants the products it manufactures against defects in materials and workmanship for a period limited to one year from the date of shipment, provided the products have been stored, handled, installed, and used under proper conditions. The Company's liability under this limited warranty shall extend only to the repair or replacement of a defective product, at The Company's option. The Company disclaims all liability for any affirmation, promise or representation with respect to the products.

The customer agrees to hold Red Lion Controls harmless from, defend, and indemnify RLC against damages, claims, and expenses arising out of subsequent sales of RLC products or products containing components manufactured by RLC and based upon personal injuries, deaths, property damage, lost profits, and other matters which Buyer, its employees, or sub-contractors are or may be to any extent liable, including without limitation penalties imposed by the Consumer Product Safety Act (P.L. 92-573) and liability imposed upon any person pursuant to the Magnuson-Moss Warranty Act (P.L. 93-637), as now in effect or as amended hereafter.

No warranties expressed or implied are created with respect to The Company's products except those expressly contained herein. The Customer acknowledges the disclaimers and limitations contained and relies on no other warranties or affirmations.

Red Lion Controls
20 Willow Springs Circle
York PA 17402
Tel +1 (717) 767-6511
Fax +1 (717) 764-0839

Red Lion Controls BV
Basicweg 11b
NL - 3821 BR Amersfoort
Tel +31 (0) 334 723 225
Fax +31 (0) 334 893 793

Red Lion Controls Asia
31, Kaki Bukit Road 3,
#06-04/05 TechLink
Singapore 417818
Tel +65 6744-6613
Fax +65 6743-3360