

Signal converters for electromagnetic flowmeters

**IFC 090 K
IFC 090 F**

How to use these Instructions

The flowmeters are supplied ready for operation.

The primary head must be installed in the pipeline as described in the installation instructions inside the packing of the primary head.

- Installation location and connection to power (Section 1)
- Electrical connection of outputs and inputs (Section 2)
- Factory settings and start-up (Section 3)

Pages 1/1-1/6

Pages 2/1-2/6

Pages 3/1-3/2

Power the flowmeter. THAT'S ALL. The system is operative.

Operator control of the IFC 090 signal converter is described in Sections 4 and 5.

Pull-out condensed instructions are located in the centrefold of this manual, pages A – D.



Contents

System description	0/4
Product liability and warranty	0/4
CE / EMC / Standards / Approvals	0/4
Items included with supply	0/4

Part A System installation and start-up **1/1-3/2**

1	Electrical connection: power supply	1/1-1/6
1.1	Location and important installation notes – PLEASE NOTE !	1/1
1.2	Connection to power	1/2
1.3	Electrical connection of separate primary head (F Version)	1/3-1/6
1.3.1	General information on signal cable A and field current cable C	1/3
1.3.2	Stripping (preparation) of signal converter	1/3
1.3.3	Grounding of primary head	1/4
1.3.4	Cable length (max. distance between signal converter and primary head)	1/5
1.3.5	Connection diagrams I and II (power supply, converter and primary head)	1/6
2	Electrical connection of outputs and inputs	2/1-2/6
2.1	Combinations of outputs and inputs	2/1
2.2	Current output I	2/1
2.3	Pulse output B1 (terminals B1 / B _⊥)	2/2
2.4	Status outputs B1 and B2 (terminals B1 / B _⊥ and B2 / B _⊥)	2/3
2.5	Control inputs B1 and B2 (terminals B1 / B _⊥ and B2 / B _⊥)	2/4
2.6	Connection diagrams for outputs and inputs	2/5-2/6
3.	Start-up	3/1-3/2
3.1	Switch-on and measurement	3/1
3.2	Factory settings	3/2

Part B IFC 090_ / D Signal converter **4/1-5/14**

4	Operation of the signal converter	4/1-4/12
4.1	Krohne operator control concept	4/1
4.2	Operating and check elements	4/2
4.3	Function of keys	4/3-4/4
4.4	Table of settable functions	4/5-4/9
4.5	Error messages in measuring mode	4/10
4.6	Reset totalizer and cancel error messages, RESET/QUIT menu	4/11
4.7	Examples of setting the signal converter	4/12
5	Description of functions	5/1-5/14
5.1	Full-scale range Q _{100%}	5/1
5.2	Time constant	5/1
5.3	Low-flow cutoff	5/2
5.4	Display	5/2-5/3
5.5	Internal electronic totalizer	5/3
5.6	Current output I	5/4
5.7	Pulse output B1	5/5-5/6
5.8	Status outputs B1 and B2	5/7
5.9	Control inputs B1 and B2	5/8
5.10	Language	5/8
5.11	Entry code	5/8
5.12	Primary head	5/9
5.13	User-defined unit	5/10
5.14	F/R mode, forward/reverse flow measurement	5/11
5.15	Characteristic of outputs	5/11
5.16	Combinations of binary outputs and inputs	5/12
5.17	Limit switches	5/12
5.18	Automatic range change BA	5/13
5.19	Applications	5/14

Part C	Special applications, functional checks, service, and order numbers	6/1-9/1
6	Special applications	6/1-6/4
6.1	Use in hazardous areas	6/1
6.2	RS 232 adapter incl. CONFIG software (option)	6/1
6.3	Stable signal outputs when measuring tube empty	6/2
6.4	Pulsating flow	6/3
6.5	Rapid changes in flowrate	6/3
6.6	Unsteady display and outputs	6/4
6.7	HART interface	6/5-6/6
7	Functional checks	7/1-7/12
7.1	Zero check with IFC 090 _ /D, signal converter, Fct. 3.03	7/1
7.2	Test of measuring range Q, Fct. 2.01	7/1
7.3	Hardware information and error status, Fct. 2.02	7/2
7.4	Faults and symptoms during start-up and process flow measurement	7/3-7/8
7.5	Test of primary head	7/9
7.6	Test of signal converter using GS 8A simulator (option)	7/10-7/12
8	Service	8/1-8/5
8.1	Replacement of power fuses	8/1
8.2	Changeover of operating voltage on AC Versions 1 and 2	8/1
8.3	Turning the display PCB	8/1
8.4	Retrofitting the display unit	8/2
8.5	Power fuses and illustrations to Sect. 8.1 to 8.4	8/2
8.6	Turning the converter housing of the compact flowmeters	8/3
8.7	IFC 090 Replacement of converter electronic unit	8/3
8.8	IFC 080 and SC 80 AS Replacement of electronic unit by IFC 090	8/4
8.9	Illustrations of the PCBs	8/5
9	Order numbers	9/1
Part D	Technical data, measuring principle and block diagram	10/1-12/1
10	IFC 090 Technical data	10/1-10/5
10.1	Full-scale range $Q_{100\%}$	10/1
10.2	IFC 090 F and ZD Dimensions and weights	10/1
10.3	Error limits at reference conditions	10/2
10.4	IFC 090 Signal converter	10/3-10/4
10.5	Instrument name plates	10/5
11	Measuring principle and function of the system	11/1
12	Block diagram - signal converter	12/1
Part E	Index	E1-E2
Printed form to accompany flowmeters returned to Krohne		E3

System description

Electromagnetic flowmeters with the IFC 090 signal converter are precision instruments designed for linear flow measurement of liquid products.

The process liquids must be electrically conductive: $\geq 5 \mu\text{S/cm}$
(for cold demineralized water $\geq 20 \mu\text{S/cm}$).

The full-scale range $Q_{100\%}$ can be set as a function of the meter size:
DN 2.5 - 1000 / 1/10" - 40" $Q_{100\%} = 0.01 - 34\,000 \text{ m}^3/\text{hr} = 0.03 - 151\,000 \text{ US Gal/min}$
This is equivalent to a flow velocity of 0.3 - 12 m/s or 1 - 40 ft/s.

Product liability and warranty

The electromagnetic flowmeters with the IFC 090 signal converter are designed solely for measuring the volumetric flowrate of electrically conductive, liquid process products.

Special codes and regulations apply to their use in hazardous areas and these are referred to in the special "Ex" Installation and Operating Instructions (supplied only with hazardous-duty equipment).

Responsibility as to suitability and intended use of these compact electromagnetic flowmeters rests solely with the operator.

Improper installation and operation of the flowmeters (systems) may lead to loss of warranty.

In addition, the "General conditions of sale" forming the basis of the purchase contract are applicable.

If flowmeters need to be returned to Krohne, please note the information given on the last-but-one page of these Instructions. Krohne regrets that it cannot repair or check your flowmeter(s) unless accompanied by the completed form sheet.

CE / EMV / Standards / Approvals

- Electro magnetic flowmeters with the IFC 090 signal converter meet the requirements of the **EU-EMC Directives** and bear the **CE symbol**.
- All factories and production sequences are **ISO 9001** certified.
- Flowmeters are approved as hazardous-duty equipment to the harmonized European Standards and to Factory Mutual (FM).
Further details are given in the "Ex" supplementary instructions provided only with hazardous-duty equipment.



Items included with supply

- Signal converter as ordered
- Installation and operating instructions
- 2 plug connectors for power supply and outputs/inputs
- Special wrench for opening the housing covers
- Bar magnet to operate the display converter without opening the housing
- Additional instructions for hazardous-duty versions (applies only to hazardous-duty equipment)

Part A System installation and start-up

1 Electrical connection: power supply

1.1 Location and important installation notes

PLEASE NOTE !

- **Electrical connection in accordance with VDE 0100** "Regulations governing heavy-current installations with line voltages up to 1000 V" or **equivalent national regulations**.
- Do not cross or loop **cables inside the terminal compartment**.
- Use **separate cable entries** (PG screwed conduit entries) for power supply, field current cables, signal lines, outputs and inputs.
- **Hazardous locations** are subject to special regulations, see Section 6.1 and special installation instructions for hazardous-duty ("Ex") versions.
- Protect flowmeters or switchgear cabinets with built-in devices from direct **sunlight**. Fit a sunshade if necessary.
- When installed in switchgear cabinets, signal converters must be adequately cooled, e.g. use fans or heat exchangers.
- Do not expose signal converters to intense **vibration**.

Only for separate systems/signal converters (F Versions)

- Keep **distance between primary head and signal converter** as short as possible. Refer to Sect. 1.3.4 for maximum permissible length of signal and field current cables.
- Use the supplied **Krohne signal cable A** (Type DS), standard length 10 m (33 ft).
- Always **calibrate** primary head and signal converter **together**. Therefore, when installing, ensure **primary constant GK is identical**; refer to instrument nameplate for the primary head. If the GK is not identical, set the signal converter to the GK of the primary head. Refer also to Sections 4 and 8.5.
- **Dimensions of signal converter**; refer to Section 10.2.

PLEASE NOTE !

- **Rated values:** The flowmeter housings protecting the electronic equipment from dust and moisture must always be kept closed. The selected creepage distances and clearances have been dimensioned in conformity with VDE 0110 and IEC 664 for contamination category 2. Supply circuits and output circuits are designed to meet the standards of overvoltage classes III and II, respectively.
- **Safety isolation:** the flowmeters (signal converters) must be provided with an isolating facility.

1. AC Version

230/240 V AC (200 - 260 V AC)
switch-selectable to
115/120 V AC (100 - 130 V AC)

2. AC Version

200 V AC (170 - 220 V AC)
switch-selectable to
100 V AC (85 - 110 V AC)

- **Note information on instrument nameplate:** supply voltage and frequency
- The **PE protective ground conductor** for the power supply **must be connected** to the separate U-clamp terminal in the terminal compartment of the signal converter. For exceptions (compact systems), refer to installation instructions for the primary head.
- **Connection diagrams I and II** for power supply and electrical connection between primary head and signal converter: refer to Section 1.3.5.

24 V AC / DC (tolerance bands: **AC** 20 - 27 V / **DC** 18 - 32 V)

- **Note information on instrument nameplate:** supply voltage and frequency.
- For measurement reasons, connect an **FE functional ground conductor** to the separate U-clamp terminal in the terminal compartment of the signal converter.
- If connected to a functional extra-low voltage source (24 V AC / DC), provide for **protective separation (PELV)** in conformity with VDE 0100 / VDE 0106 or IEC 364 / IEC 536, or equivalent national regulations.
- **Connection diagrams I and II** for power supply and electrical connection between primary head and signal converter: refer to Section 1.3.5.

Connection to power



↑
for
internal
use only

L N
1L≈ 0L≈



PE 100 - 240 V AC

FE 24 V AC/DC

(PE protective ground conductor)

(FE functional ground conductor)

Warning: Instrument must be properly grounded to avoid personnel shock hazard.

1.3 Electrical connection of separate primary head (F Versions)

1.3.1 General information on signal cable A and field current cable C

Use of the Krohne signal cable A with foil screen and magnetic shield will ensure proper operation of the equipment.

- Signal cable to be solidly laid.
- Connect shields via stranded drain wires.
- Underwater and underground installation possible.
- Insulating material is flame-retardant to IEC IEC 332.1 / VDE 0742.
- Signal cables are low in halogen, unplasticized, and stay flexible at low temperatures.

Signal cable A (Type DS), with double shielding

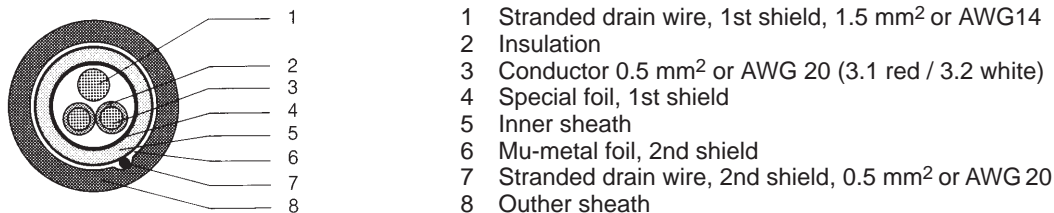

Field current cable C with single shielding

Cross-section is dependent on required length of cable, see Table in Sect. 1.3.4.

1.3.2 Stripping (preparation) of signal cable A

Please note the different lengths given in the table for signal converter and primary head.

Length	Converter	Primary head
	mm (inch)	mm (inch)
a	70 (2.80)	90 (3.60)
b	08 (0.30)	08 (0.30)
c	25 (1.00)	25 (1.00)
d	08 (0.30)	08 (0.30)
e	50 (2.00)	70 (2.80)

Customer-supplied materials

W	Insulation tubing (PVC), 2.0 - 2.5 mm dia. (1")
X	Heat-shrinkable tubing or cable sleeve
Y	Wire end sleeve to DIN 41 228: E 1.5-8
Z	Wire end sleeve to DIN 41 228: E 0.5-8

Please note:

For primary heads, stranded drain wire ① must have the same length as stranded drain wire 7.

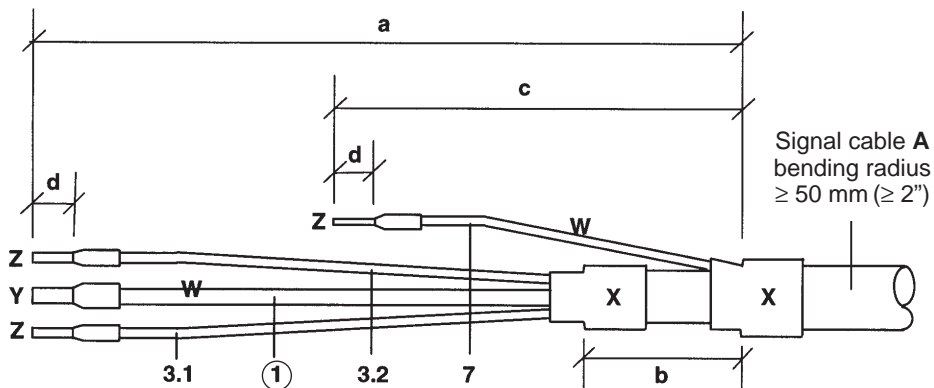

See Section 1.3.4 for max. permissible cable lengths

- All flowmeters must be properly grounded.
- The grounding conductor should not transmit any interference voltages.
- Do not ground any other electrical device together with this conductor.
- In hazardous locations, the grounding conductor is used simultaneously for equipotential bonding. Special grounding instructions are contained in the "Ex" installation instructions for hazardous-duty devices, supplied only with such devices).
- The primary head is connected to ground by means of an **FE functional ground conductor**.
- Special information on grounding various primary heads is contained in the separate **installation instructions for primary heads**.
- These instructions also contain detailed descriptions on how to use grounding rings and how to install primary heads in metal or plastic pipes or internally coated pipelines.

1.3.4 Cable lengths (max. distance between signal converter and primary head)

Abbreviations and explanatory notes

used in the following tables, diagrams and connection diagrams

- A Signal cable A** (type DS), with double shielding, see diagram for max. length
- C Field current cable C**, with single shielding, type and length see Table
- D** High-temperature silicone cable, $3 \times 1.5 \text{ mm}^2$ (14 AWG) Cu, with single shielding, max. length 5 m (16 ft)
- E** High-temperature silicone cable, $2 \times 1.5 \text{ mm}^2$ (14 AWG) Cu, max. length 5 m (16 ft)
- L** Cable length
- κ Electrical conductivity of the process liquid
- ZD** Intermediate connection box required in connection with cables D and E for primary heads ALTOFLUX IFS 4000 F, PROFIFLUX IFS 5000 F and VARIFLUX IFS 6000 F in cases where process temperatures exceed $150 \text{ }^\circ\text{C}$ ($302 \text{ }^\circ\text{F}$)

Recommended length of signal cable

for magnetic field frequency $\leq 1/6 \times$ power frequency

Primary head	Meter size		Signal line
	DN mm	inch	
ECOFLUX IFS 1000 F	10 - 15	$3/8 - 1/2$	A4
	25 - 150	1 - 6	A3
AQUAFLUX F	10 - 1000	$3/8 - 40$	A1
ALTOFLUX IFS 4000 F	10 - 150	$3/8 - 6$	A2
	200 - 1000	8 - 40	A1
PROFIFLUX IFS 5000 F	2.5 - 15	$1/10 - 1/2$	A4
	25 - 100	1 - 4	A2
VARIFLUX IFS 6000 F	2.5 - 15	$1/10 - 1/2$	A4
	25 - 80	1 - 3	A2

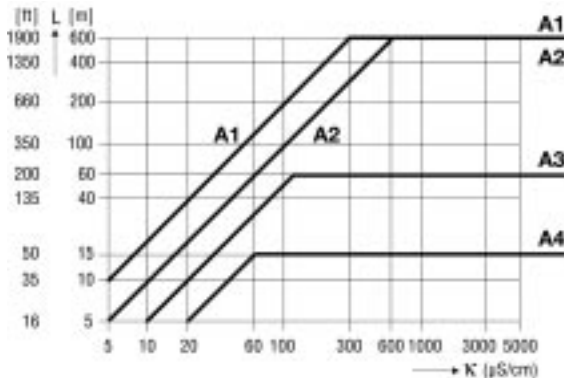

Field current cable C: max. length and min. crosssection

Length	Type of cable, single shielding
0 - 150 m 5 - 500 ft	$2 \times 0,75 \text{ mm}^2$ Cu / 2×18 AWG
150 - 300 m 500 - 1000 ft	$2 \times 1,50 \text{ mm}^2$ Cu / 2×14 AWG
300 - 600 m 1000 - 1900 ft	$2 \times 2,50 \text{ mm}^2$ Cu / 2×12 AWG

2 Electrical connection of outputs and inputs

2.1 Combinations of outputs and inputs

Assignment of the binary outputs and inputs as required, see 3.07 Fct. "HARDWARE" and Sect. 3.2 "Factory settings".

Current output I – active or passive mode
– internal power source for the binary outputs and inputs

Binary outputs/inputs

- **terminal B1:**
pulse output B1
status output B1 or
control input B1
- **terminal B2:**
status output B2 or
control input B2

Terminals

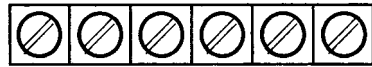

B1 **B.L** **B2** **I+** **I** **I.L**

Binary outputs
and inputs

Current output

Output/input combinations 1) – 6)

Terminals:	<u>I+ / I / I.L</u>	<u>B1 / B.L</u>	<u>B2 / B.L</u>	
Combination:	1) I	P	S	
	2) I	P	C	
	3) I	C	S	I = current output
	4) I	S	C	P = pulse output
	5) I	S1	S2	S = status output
	6) I	C1	C2	C = control input

2.2 Current output I

- The current output is galvanically isolated from all input and output circuits.
- Setting data and functions can note down on page 0/3.
Please also refer to Sect. 3.2 "Factory settings".
- Typical current output

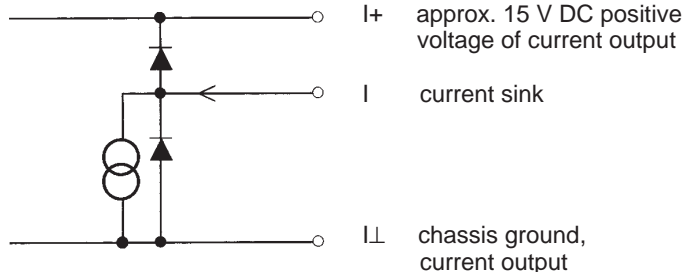

- All operating data and functions can be set.
- **Display** version: IFC 090 **D**, see Sect. 4 and 5.6, Fct. 1.05 for operator control
Basic version: IFC 090 **B**, see Sect. 6.2 for operator control
- The current output can also be used as an internal voltage source for the binary outputs and inputs.
 $U_{int} = 15 \text{ V DC}$ $I = 23 \text{ mA}$ when operated **without** receiver instruments at the current output
 $I = 3 \text{ mA}$ when operated **with** receiver instruments at the current output
- **Connection diagrams**, see Sect. 2.6: diagrams ① ② ③ ⑥ ⑨ ⑩ ⑪

- The pulse output is galvanically isolated from the current output and all input circuits.
- Setting data and functions can note down on page 0/3.
Please also refer to Sect. 3.2 “Factory settings” and Sect. 2.1 “Combinations of the binary outputs and inputs”, Fct. 3.07 HARDWARE.
- Typical pulse output B1

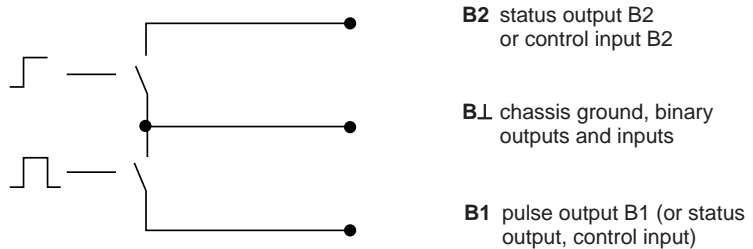

- All operating data and functions can be set:
Display version: IFC 090 **D**, see Sect. 4 and 5.7, Fct. 1.06 for operator control
Basis version: IFC 090 **B**, see Sect. 6.2 for operator control
- The pulse output can be operated in the active or passive mode.
 Active mode: The current output is the internal voltage source, connection of electronic totalizers (EC)
 Passive mode: External DC or AC voltage source required, connection of electronic (EC) or electromechanical (EMC) totalizers
- Digital pulse division, interpulse period is non-uniform. Therefore, if frequency meters or cycle counters are connected, allow for minimum counting interval:

$$\text{gate time, counter} \leq \frac{1000}{P_{100\%} [\text{Hz}]}$$

- **Connection diagrams**, see Sect. 2.6: diagrams ③ ④ ⑤ ⑨

2.4 Status outputs B1 and B2 (terminals B1 / B.L and B2 / B.L)

- The status outputs are galvanically isolated from the current output and all input circuits.
- Setting data and functions can note down on page 0/3.
Please also refer to Sect. 3.2 “Factory settings” and Sect. 2.1 “Combinations of binary outputs and inputs”, Fct. 3.07 HARDWARE.
- Typical status outputs B1 and B2



- All operating data and functions can be set:
Display version: IFC 090 **D**, see Sect. 4 and 5.8, Fct 1.06 or 1.07 for operator control
Basic version: IFC 090 **B**, see Sect. 6.2 for operator control
- The status outputs can be operated in the active or passive mode.
 Active mode: The current output is the internal voltage source.
 Passive mode: External DC or AC voltage source required.

Characteristics of the status outputs	Switch open	Switch closed
OFF (switched off)	no function	
ON (e.g. operation indicator)	power OFF	power ON
SIGN I (F/R mode)	Forward flow	Reverse flow
SIGN P (F/R mode)	Forward flow	Reverse flow
TRIP POINT (limit switch)	inactive	active
AUTO RANGE (automatic range change)	high range	low range
OVERFLOW I (I overranged)	current output OK	current output overranged
OVERFLOW. P (P overranged)	pulse output OK	pulse output overranged
ALL. ERROR (all errors)	errors	no error
FATAL.ERROR (fatal errors only)	errors	no error
EMPTY PIPE (option)	when measuring tube is empty	when measuring tube is full

Connection diagrams, see Sect. 2.6: diagrams ⑥ ⑦ ⑨ ⑩ ⑪

- The control inputs are galvanically isolated from the current output and all input circuits.
- Setting data and functions can note down on page 0/3.
Please also refer to Sect. 3.2 “Factory settings” and Sect. 2.1 “Combinations of binary outputs and inputs”, Fct. 3.07 HARDWARE.
- Typical current inputs B1 and B2

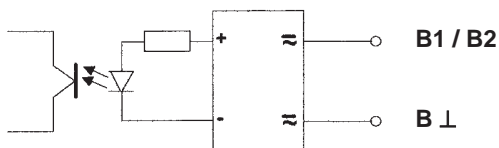

- All operating data and functions can be set:
Display version: IFC 090 **D**, see Sect. 4 and 5.19, Fct. 1.06 and 1.07 for operator control
Basic version: IFC 090 **B**, see Sect. 6.2 for operator control
- The control inputs must be operated in the passive mode.

• **Function of the control inputs**

OFF	switched off
EXT. RANGE	external range change
OUTP. HOLD	hold value of outputs
OUTP. ZERO	set outputs to “MIN.VALUES”
TOTAL.RESET	reset totalizer(s)
ERROR.RESET	delete error messages

Connection diagram, see Sect. 2.6: diagram ⑧

2.6 Connection diagrams for outputs and inputs



Milliammeter



Totalizer

- electronic (EC)
- electromechanical (EMC)



DC voltage, external power source (U_{ext}), note connection polarity



External voltage source (U_{ext}), DC or AC voltage, connection polarity arbitrary



Key, N/O contact



Relay for forward/reverse flow measurement (F/R) and/or automatic range change (BA) with 1 or 2 changeover contacts



Please note! This terminal is **not provided for hazardous-duty signal converters**. There is no passive current output, see connection diagrams (2), (3), (6) and (11).

1 Current output I_{active}

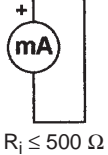

$$R_i \leq 500 \Omega$$

2 Current output $I_{passive}$

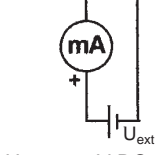

$$U_{ext} \leq 15 \text{ V DC}$$

$$R_i \leq 500 \Omega$$

Active mode

The current output supplies the power for operation of the inputs and outputs.

Passive mode

External power source required for operation of the inputs and outputs.

3 Pulse output P_{active} for EC

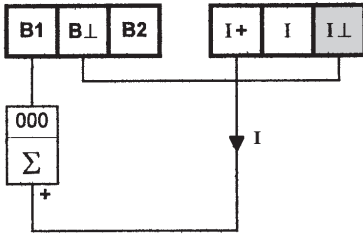

$U \leq 15 \text{ V DC}$ from current output
 $I \leq 23 \text{ mA}$ operation **without** current output
 $I \leq 3 \text{ mA}$ operation **with** current output

4 Pulse output $P_{passive}$ for EC or EMC

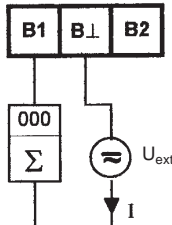

$U_{ext} \leq 32 \text{ V DC} / \leq 24 \text{ V AC}$
 $I \leq 150 \text{ mA}$

5 Pulse output $P_{passive}$ active EC

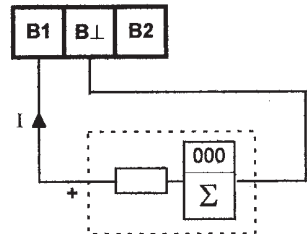

$U_{ext} \leq 32 \text{ V DC}$
 $I \leq 150 \text{ mA}$

6 Status output S_{active} (connection to B2 and/or B1)

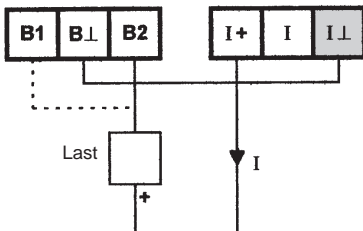

$U \leq 15 \text{ V DC}$ from current output
 $I \leq 23 \text{ mA}$ operation **without** current output
 $I \leq 3 \text{ mA}$ operation **with** current output

7 Status output $S_{passive}$ (connection to B2 and/or B1)

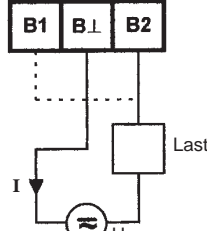

$U_{ext} \leq 32 \text{ V DC} / \leq 24 \text{ V AC}$
 $I \leq 150 \text{ mA}$

8 Control input $C_{passive}$ (connection to B2 and/or B1)

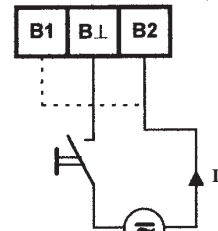

$U_{ext} \leq 32 \text{ V DC} / \leq 24 \text{ V AC}$
 $I \leq 6 \text{ mA}$

9 **F/R flow measurement**
 I_{active} and P_{passive} (B1)
 F/R changeover via S_{passive} (B2)

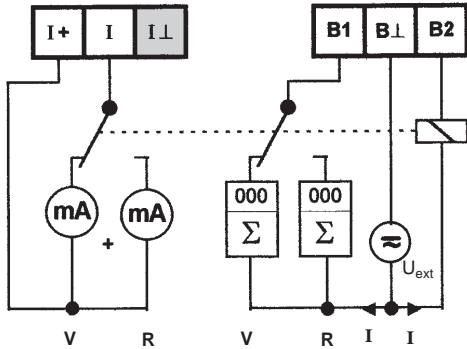

$U_{\text{ext}} \leq 32 \text{ V DC} / \leq 24 \text{ V AC}$
 $I \leq 150 \text{ mA}$

Relay type
 e.g. Siemens D1

10 **Automatic range change (BA) with F/R flow measurement**
 I_{active} / BA changeover via $S2_{\text{passive}}$ (B2) / F/R changeover via $S1_{\text{passive}}$ (B1)

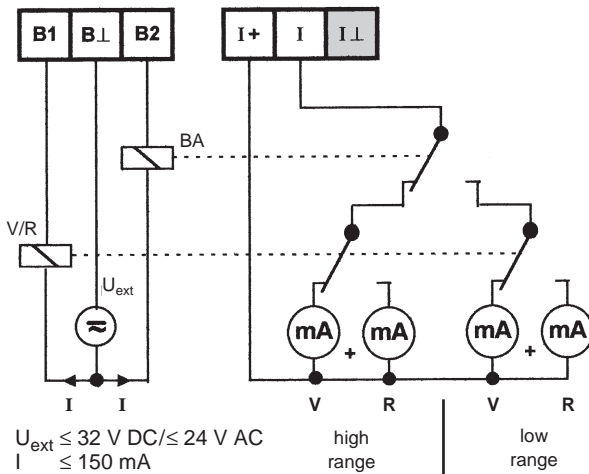

$U_{\text{ext}} \leq 32 \text{ V DC} / \leq 24 \text{ V AC}$
 $I \leq 150 \text{ mA}$

Relay type
 e.g. Siemens D1

11 **Automatic range change (BA)**
 I_{active} / BA changeover via S_{active} (B2)

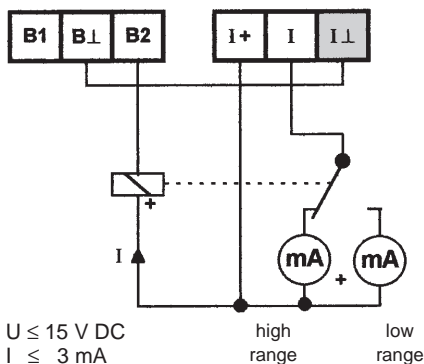



$U \leq 15 \text{ V DC}$
 $I \leq 3 \text{ mA}$

Relay type
 e.g. NAIS-Matsushita
 type RH-C or DR-C

3.1 Switch-on and measurement

- Before powering the system, please check that it has been correctly installed according to Sect. 1 and 2.
- The flowmeter is delivered ready for operational use. All operating data have been factory set in accordance with your specifications.
Please refer to Sect. 3.2 “factory settings”.
- Power the unit, and the flowmeter will immediately start process flow measurement.

Basic version, signal converter IFC 090__ / B

- A light emitting diode (LED) under the cover of the electronic section shows the measurement status. Remove the cover using the special wrench.
LED flashing . . .
 -  **green:** measurement correct, everything all right.
 -  **green/red:** momentary overdriving of outputs and/or A/D converter.
 -  **red:** fatal error, parameter error or hardware fault, please consult factory.
- Refer to Sect. 6.2 for operator control of the “basic version”.

Display version, signal converter IFC 090__ / D

- When powered, the display shows in succession: START UP and READY. This is followed by display of the current flow rate and/or the current totalizer count on either a continuous or alternating basis, depending on the setting under Fct. 1.04.
- Refer to Sect. 4 and 5 for operator control of the “display version”.

All operating data are factory set according to your order specifications.

If you have not made any particular specifications at the time of ordering, the instruments will be delivered with the standard parameters and functions listed in the Table below.

To facilitate easy and rapid initial start-up, current output and pulse output are set to process flow measurement in “2 flow directions”, so that the current flowrate is displayed and the volumetric flow counted independent of the flow direction. On instruments equipped with a display, measured values may possibly be shown with a “-” sign.

This factory setting for the current and pulse outputs may possibly lead to measuring errors, particularly in the case of volume flow counting:

for example, if pumps are switched off and a “backflow” occurs which is not within the range of the low-flow cutoff (SMU), or if separate displays and counts are required for both flow directions.

To avoid faulty measurements, therefore, it may be necessary to change the factory setting of some or all of the following functions:

- low-flow cutoff SMU, Fct. 1.03, Sect. 5.3
- current output I, Fct. 1.05, Sect. 5.6
- pulse output P, Fct. 1.06, Sect. 5.7
- display (option), Fct. 1.04, Sect. 5.4

For special applications, for example “pulsating flow”, see Sect. 6.

Instrument operation:

Display versions: IFC 090 _ / **D**, operation: refer to **Sect. 4 and 5**.

Basic versions: IFC 090 _ / **B**, operation: refer to **Sect. 6.2**.

Table of standard factory settings

Function		Setting
1.01	Full-scale range $Q_{100\%}$	see nameplate
1.02	Time constant	3 s, for I, S and display
1.03	Low-flow cutoff SMU	ON: 1 % OFF: 2 %
1.04	Display (option) flow rate totalizer(s)	m^3/hr or US Gal/min m^3 or US Gal
1.05	Current output I function range error message	2 directions 4 - 20 mA 22 mA
1.06	Pulse output B1 function pulse value pulse width	2 directions 1 pulse/s 500 ms
1.07	Status output B2	flow direction

Function		Setting
3.01	Language for display only	English
3.02	Flowmeter diameter flow direction (see arrow on primary head)	see nameplate } + direction
3.04	Entry code	no
3.05	User unit	Liter/hr or USMGal/day
3.06	Application	steady
3.07	Hardware Terminal B1 Terminal B2	pulse output status output

Part B IFC 090 _ / D Signal converter

4 Operation of the signal converter

4.1 Krohne operator control concept

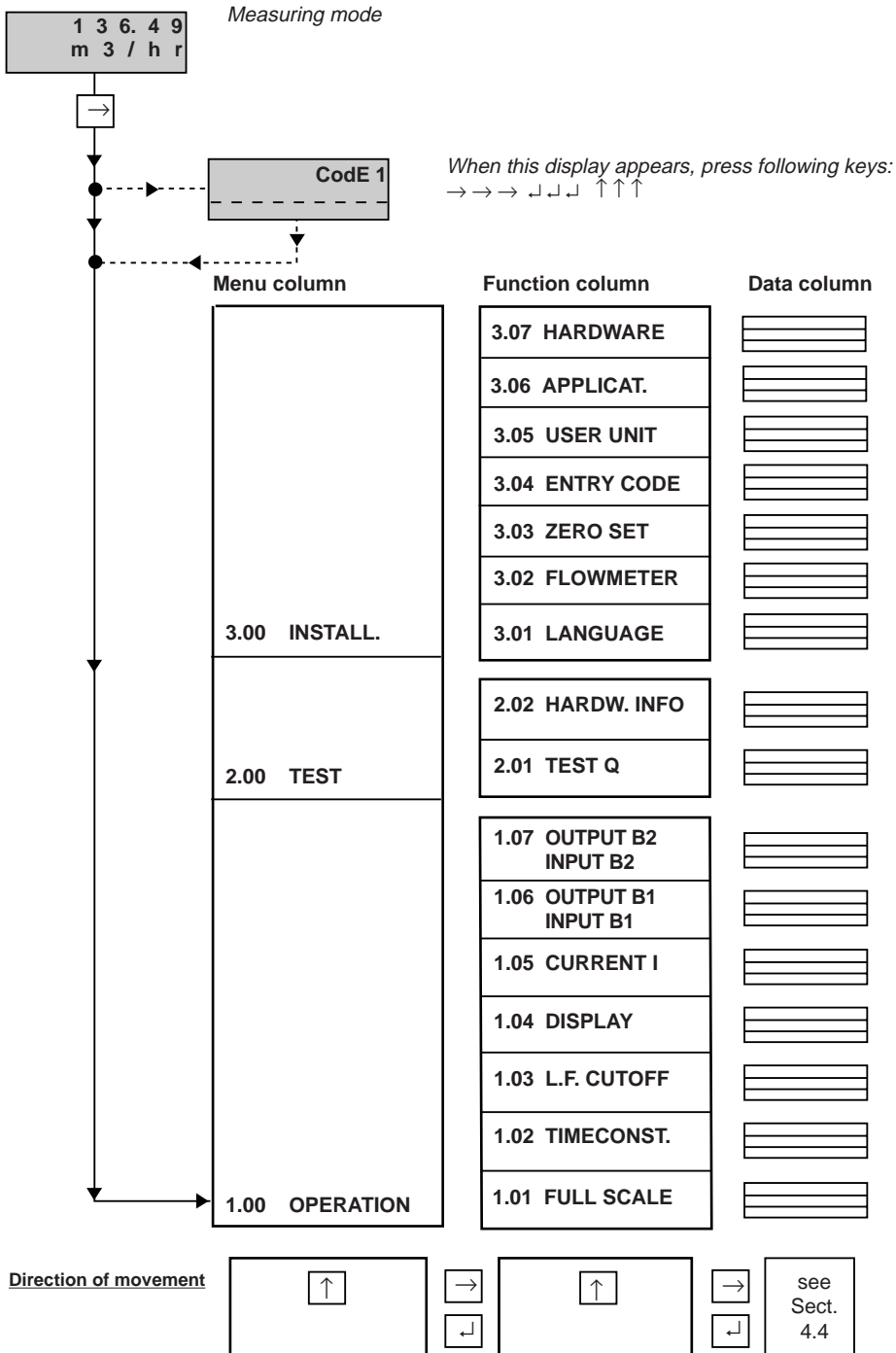

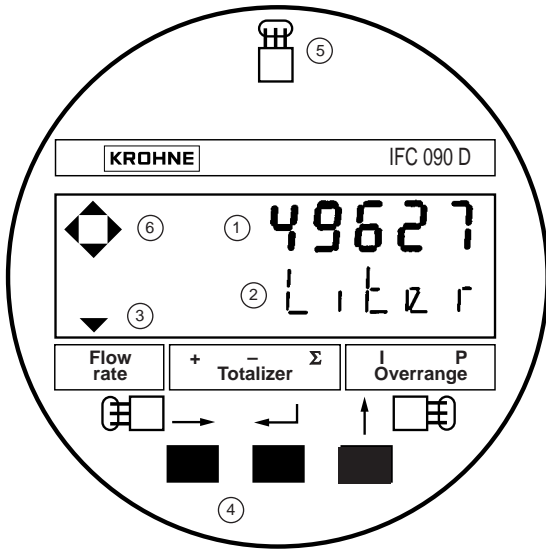

Operator control by way of ...

- ... **the 3 keys** (4). The keys are accessible after unscrewing the cover of the electronic section using the special wrench (supplied).
- ... **the 3 magnetic sensors** (5) and the **supplied bar magnet** without opening the housing.

PLEASE NOTE!

Do not damage the screw thread and the gasket, never allow dirt to accumulate, and make sure they are well greased at all times.
 Damaged gasket must be replaced immediately!

- (1) Display, 1st line
- (2) Display, 2nd line
- (3) Display, 3rd line: arrows to identify display

<i>Flowrate</i>		current flowrate
<i>Totalizer</i>	+	totalizer
	-	totalizer
	Σ	sum totalizer (+ and -)
<i>Overrange</i>	I	overranging, current output I
	P	overranging, pulse output P

- (4) Keys for operator control of signal converter
- (5) Magnetic sensors to set the converter by means of a handheld bar magnet without opening housing. Function of sensors same as keys (4).
- (6) Compass field, signals actuation of a key.

4.3 Function of keys

The **cursor** (flashing part of display) has a **grey** background in the following descriptions.

To start operator control

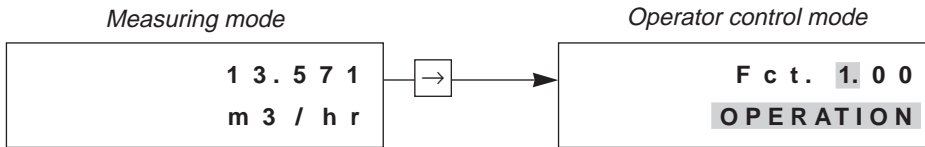

PLEASE NOTE: When "YES" is set under **Fct. 3.04 ENTRY CODE**, "CodE 1 - - - - -" appears in the display after pressing the → key.

The 9-keystroke Entry Code 1 must now be entered: →→→ ↵↵↵ ↑↑↑
(each keystroke acknowledged by "*").

To terminate operator control

Press key ↵ repeatedly until one of the following menus

Fct. 1.00 OPERATION, Fct. 2.00 TEST or **Fct. 3.00 INSTALL.** is displayed.

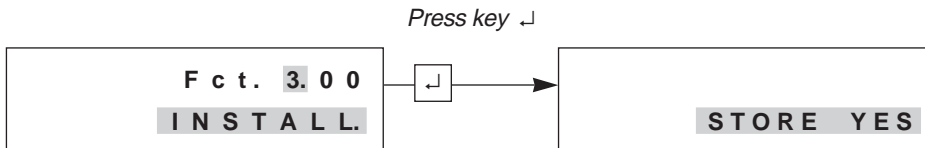

Store new parameters: acknowledge by pressing key ↵. Measuring mode continued with the new parameters.

New parameters not to be stored: press key ↑ to display „STORE.NO“. Measuring mode continued with the „old“ parameters after pressing key ↵.

To change numbers

select next number

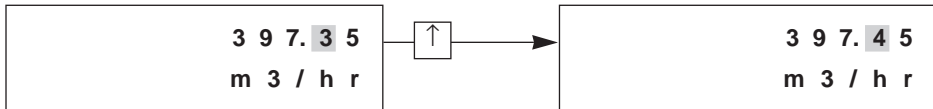

To shift cursor (flashing position)

shift to right

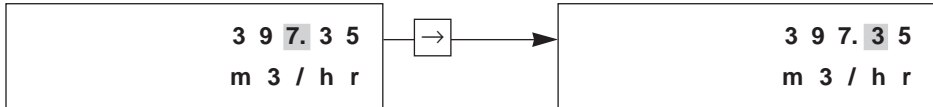

To alter texts (units)

For units, the numerical value is converted automatically.

select next text

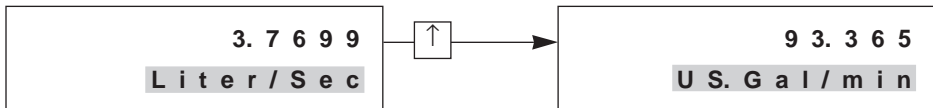

To transfer from text (unit) to number setting

Change to number setting

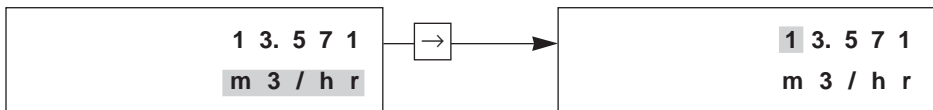

To transfer to subfunction

Subfunctions do not have a "Fct.No." and are identified by a "→".

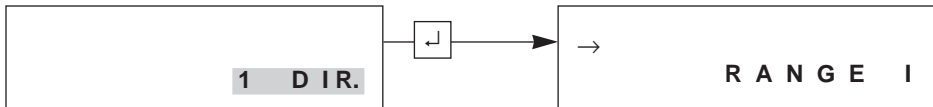

To revert to function display

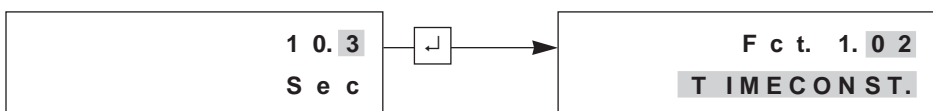

Fct.	Text	Description and settings	
1.04	DISPLAY	Display functions	
	→ DISP.FLOW	Select flow display <ul style="list-style-type: none"> • NO DISP. • user unit, factory set is "Liter/hr" or "US MGal/day (see Fct. 3.05) • m3/hr • PERCENT • Liter/Sec • BARGRAPH (value and bargraph display in %) • US.Gal/min <i>Press ↵ key to transfer to subfunction "DISP. TOTAL."</i>	
	→ DISP.TOTAL.	Select totalizer display <ul style="list-style-type: none"> • NO DISP. (totalizer switched on but not displayed) • OFF (totalizer switched off) • m3 • Liter • US.Gal • user unit, factory set is "Liter" or "US MGal" (see Fct. 3.05). <i>Press → key to transfer to format setting.</i> <p>Format setting</p> <ul style="list-style-type: none"> • Auto (exponent notation) • # . ##### • ##### . ### • ## . ##### • ##### . ## • ### . ##### • ##### . # • #### . ##### • ##### <i>Press ↵ key to transfer to subfunction "DISP.MSG."</i>	
	→ DISP.MSG.	Additional messages required in measuring mode? <ul style="list-style-type: none"> • NO • YES (cyclic change with displays of measured values) <i>Press ↵ key to return to Fct. 1.04 DISPLAY.</i>	
1.05	CURRENT I	Current output I	
	→ FUNCT. I	Select function for current output I <ul style="list-style-type: none"> • OFF (switched off) • 1 DIR. (1 flow direction) • 2 DIR. (forward/reverse flow, F/R flow measurement) <i>Press key ↵, transfer to subfunction "RANGE I"; if "2 DIR." selected, transfer to subfunction "REV.RANGE"!</i>	
	→ REV.RANGE	Set full-scale range for reverse flow of Q_{100%} (appears only when "2 DIR." selected) <ul style="list-style-type: none"> • 100 PCT (same as forward flow Q_{100%}, see Fct. 1.01) • PERCENT setting range: 005 - 150% of Q_{100%} (different value for reverse flow) <i>To transfer to number setting, press key → ! Press key ↵ to transfer to subfunction "RANGE I".</i>	
	→ RANGE I	Select measuring range <ul style="list-style-type: none"> • 0 - 20 mA • 4 - 20 mA (fixed ranges) • mA (user-defined range) $\frac{I_{0\%}}{0 - 16 \text{ mA}} - \frac{I_{100\%}}{4 - 20 \text{ mA}}$ (Value $I_{0\%} < I_{100\%}$!) <i>To transfer to number setting, press key → ! Press key ↵ to transfer to subfunction "I ERROR".</i>	
	→ I ERROR	Select error value <ul style="list-style-type: none"> • 22 mA • 0.0 to I_{0%} mA (variable, see above if I_{0%} > 1 mA) <i>To transfer to number setting, press key → ! Press key ↵ to revert to Fct. 1.05 CURRENT. I.</i>	
1.06	Output/input B1		
	PULS. B1 STATUS B1 CONTROL B1	Pulse output B1 Status output B1 Control input B1 <table style="display: inline-table; vertical-align: middle;"> <tr> <td style="font-size: 2em;">}</td> <td>B1 = terminal, assigned as output or input, see Fct. 3.07 "HARDWARE"</td> </tr> </table> <p>Functional description of pulse output B1, status output B1 or control input B1, see next page.</p>	}
}	B1 = terminal, assigned as output or input, see Fct. 3.07 "HARDWARE"		
1.07	Output/input B2		
	STATUS B2 CONTROL B2	Status output B2 Control input B2 <table style="display: inline-table; vertical-align: middle;"> <tr> <td style="font-size: 2em;">}</td> <td>B2 = terminal, assigned as output or input, see Fct. 3.07 "HARDWARE"</td> </tr> </table> <p>Functional description of status output B2 or control input B2, see next page.</p>	}
}	B2 = terminal, assigned as output or input, see Fct. 3.07 "HARDWARE"		

Fct.	Text	Description and settings
2.00	TEST	Test menu
2.01	TEST Q	Test measuring range Q <u>Precautionary query</u> <ul style="list-style-type: none"> • SURE NO <i>Press ↓ key to return to Fct. 2.01 "TEST Q".</i> • SURE YES <i>Press ↓ key, then use ↑ key to</i> <i>select value: -110 / -100 / -50 / -10 / 0 / +10 / +50 / +100 / +110 PCT.</i> <i>of set full-scale range Q_{100%}.</i> <i>Displayed value present at outputs I and P.</i> <i>Press ↓ key to return to Fct. 2.01 "TEST Q".</i>
2.02	HARDW. INFO	Hardware information and error status Before consulting factory, please note down all 6 codes.
	→ MODUL ADC	X . X X X X X . X X Y Y Y Y Y Y Y Y Y Y <i>Press ↓ key to transfer to "MODUL IO".</i>
	→ MODUL IO	X . X X X X X . X X Y Y Y Y Y Y Y Y Y Y <i>Press ↓ key to transfer to "MODUL DISP.".</i>
	→ MODUL DISP.	X . X X X X X . X X Y Y Y Y Y Y Y Y Y Y <i>Press ↓ key to return to Fct. 2.02 "HARDW. INFO".</i>
3.00	INSTALL.	Installation menu
3.01	LANGUAGE	Select language for display texts <ul style="list-style-type: none"> • GB / USA (English) • D (German) • F (French) • others on request <i>Press ↓ key to return to Fct. 3.01 "LANGUAGE".</i>
3.02	FLOWMETER	Set data for primary head
	→ DIAMETER	Select size from meter size table <ul style="list-style-type: none"> • DN 10 - 1000 mm equivalent to 3/8 - 40 inch <i>Select with ↑ key.</i> <i>Press ↓ key to transfer to subfunction "FULL SCALE".</i>
	→ FULL SCALE	Full-scale range for flow Q_{100%} To set, refer to Fct. 1.01 "FULL SCALE" above. <i>Press ↓ key to transfer to subfunction "GK VALUE".</i>
	→ VALUE P	Pulse value (Fct. 1.06 "VALUE P") has been changed. With the "old" pulse values the output frequency (F) would have been exceeded or not reached. $P_{min} = F_{min} / Q_{100\%}$ $P_{max} = F_{max} / Q_{100\%}$ Check new values!
	→ GK VALUE	Set primary constant GK see primary head nameplate. Range: • 1.0000 - 9.9999 <i>Press ↓ key to transfer to subfunction "FIELD. FREQ.".</i>
	→ FIELD FREQ.	Magnetic field frequency Values: 1/2, 1/6, 1/18 and 1/36 of power frequency, see nameplate. <i>Press ↓ key to transfer to subfunction "FLOW DIR.";</i> DC units only: to transfer to subfunction "LINE FREQ.".
	→ LINE FREQ.	Normal line frequency in your country <u>Please note:</u> This function is only provided for units with DC power supply to suppress line-frequency interference. Values: 50 Hz and 60 Hz <i>Press ↓ key to transfer to subfunction "FLOW DIR.".</i>
	→ FLOW DIR.	Define flow direction (in F/R mode: forward flow). Set according to direction of arrow on primary head: • + DIR. • - DIR. <i>Select using ↑ key.</i> <i>Press ↓ key to return to Fct. 3.02 "FLOWMETER".</i>

Fct.	Text	Description and settings
3.03	ZERO SET	<p>Zero calibration</p> <p><u>Note:</u> Carry out only at "0" flow and with completely filled measuring tube!</p> <p><u>Precautionary_query</u></p> <ul style="list-style-type: none"> • CALIB. NO Press \downarrow key to return to Fct. 3.03 "ZERO SET". • CALIB. YES Press \downarrow key to start calibration. Duration approx. 25 seconds, current flowrate displayed in the selected unit (see Fct. 1.04 "DISP. FLOW"). <p>A "WARNING" sign appears when flowrate "> 0"; acknowledge by pressing \downarrow key.</p> <ul style="list-style-type: none"> • STORE NO (do not store new zero value) • STORE YES (store new zero value) <p>Press \downarrow key to return to Fct. 3.03 "ZERO SET".</p>
3.04	ENTRY CODE	<p>Entry code required to enter setting mode?</p> <ul style="list-style-type: none"> • NO (= entry with \rightarrow only) • YES (= entry with \rightarrow and Code 1: $\rightarrow \rightarrow \rightarrow \downarrow \downarrow \downarrow \uparrow \uparrow \uparrow$) <p>Press \downarrow to return to Fct. 3.04 "ENTRY CODE".</p>
3.05	USER UNIT	<p>Set any required unit for flowrate and counting</p>
	\rightarrow TEXT VOL.	<p>Set text for required flowrate unit (max. 5 characters) Factory-set: "Liter" or "MGal". <u>Characters assignable to each place:</u></p> <ul style="list-style-type: none"> • A-Z, a-z, 0-9, or " " (= blank character). <p>Press \downarrow key to transfer to subfunction "FACT. VOL."</p>
	\rightarrow FACT. VOL.	<p>Set conversion factor (F_M) for volume Factory set "1.00000" for "Liter" or "2.64172E-4" for "US MGal" (exponent notation, here: 1×10^3 or 2.64172×10^{-4}). Factor F_M = volume per $1m^3$. <u>Setting range</u> • 1.00000 E-9 to 9.99999 E+9 (= 10^{-9} to 10^{+9}) Press \downarrow key to transfer to subfunction "TEXT TIME".</p>
	\rightarrow TEXT TIME	<p>Set text for required time unit (max. 3 characters) Factory-set: "hr" or "day". <u>Characters assignable to each place:</u></p> <ul style="list-style-type: none"> • A-Z, a-z, 0-9, or " " (= blank character). <p>Press \downarrow key to transfer to subfunction "FACT. TIME"</p>
	\rightarrow FACT. TIME	<p>Set conversion factor (F_T) for time Factory-set: "3.60000 E+3" for "hour" or "8.64000 E+4" for "day" (exponent notation, here: 3.6×10^3 or 8.64×10^4). Set factor F_T in seconds. <u>Setting range</u> • 1.00000 E-9 to 9.99999 E+9 (= 10^{-9} to 10^{+9}) Press \downarrow key to return to Fct. 3.05 "USER UNIT".</p>
3.06	APPLICAT.	<p>Set overload point for A/D converter</p>
	\rightarrow FLOW	<ul style="list-style-type: none"> • STEADY (150% of $Q_{100\%}$) • PULSATING (1000% of $Q_{100\%}$) <p>Press key \downarrow to return to Fct. 3.06 "APPLICAT.", with installed option "empty pipe", change to subfunction "EMPTY PIPE".</p>
	\rightarrow EMPTY PIPE	<p>Switch on "empty pipe" identifier option? (appears only when this option is installed)</p> <ul style="list-style-type: none"> • YES • NO Select with key \uparrow. <p>Press \downarrow key to return to Fct. 3.06 "APPLICAT."</p>
3.07	HARDWARE	<p>Assign outputs and inputs to terminals B1 and B2</p>
	\rightarrow TERM.B1	<p>Terminal B1</p> <ul style="list-style-type: none"> • PULSOUTP. • STATUSOUTP. • CONTROLINP. <p>Select with key \uparrow. Press key \downarrow to transfer to subfunction "TERM. B2".</p>
	\rightarrow TERM.B2	<p>Terminal B2</p> <ul style="list-style-type: none"> • STATUSOUTP. • CONTROLINP. <p>Select with key \uparrow. Press key \downarrow to return to Fct. 3.07 "HARDWARE".</p>

The following list gives all errors that can occur during process flow measurement.
Errors shown in display when "YES" set in Fct. 1.04 DISPLAY, subfunction "DISP. MSG.":

Error messages	Description of error	Error clearance
LINE INT.	Power failure <u>Note:</u> no counting during power failure	Cancel error in RESET-QUIT menu Reset totalizer if necessary.
OVERFLOW I	Current output overranged.	Check and if necessary correct instrument parameters. After elimination of cause, error message deleted automatically.
OVERFLOW P	Pulse output overranged. <u>Note:</u> totalizer deviation possible.	Check and if necessary correct instrument parameters. After elimination of cause, error message deleted automatically.
TOTALIZER	Totalizer has been reset	Cancel error message in RESET/QUIT. menu.
ADC	Analog / digital converter overranged	Error message deleted automatically after elimination of cause.
FATAL. ERROR	Fatal error, all outputs set to "min. values"	Please consult factory.
EMPTY PIPE	Pipe has run dry. This message appears only when the " empty pipe identifier " option is installed and the function is switched on under Fct. 3.06 APPLICAT., submenu "EMPTY PIPE".	Fill pipe.

4.6 Reset totalizer and cancel error messages, RESET/QUIT menu

Cancel error messages in RESET / QUIT menu

Key	Display		Description
	-----	-----/---	Measuring mode
↵	CodE 2	--	Key in entry code 2 for RESET/QUIT menu: ↑ →
↑ →		ERROR QUIT.	Menu for error acknowledgement
→		QUIT. NO	Do not delete error messages, press ↵ twice = return to measuring mode
↑		QUIT. YES	Delete error messages
↵		ERROR QUIT.	Error messages deleted
↵	-----	-----/---	Return to measuring mode

Reset totalizer(s) in RESET / QUIT menu

Key	Display		Description
	-----	-----/---	Measuring mode
↵	CodE 2	--	Key in entry code 2 for RESET/QUIT menu: ↑ →
↑ →		ERROR QUIT.	Menu for error acknowledgement
↑		TOTAL. RESET	Menu for resetting totalizer
→		RESET NO	Do not reset totalizer, press ↵ twice = return to measuring mode
↑		RESET. YES	Reset totalizer
↵		RESET QUIT.	Totalizer reset
↵	-----	-----/---	Return to measuring mode

The **cursor**, flashing part of display, is shown below in **bold** type.

- **Change measuring range of current output and value for error messages** (Fct. 1.05):
- Change measuring range from 04-20 mA to **00-20 mA**
- Change value for error messages from 0 mA to **22 mA**

Key	Display	Description
→	Fct. 1.00	If "YES" set under Fct. 3.04 ENTRY CODE, key in the 9-keystroke CODE 1 now: →→→↑↑↑↓↓↓ If "REV. RANGE" appears here, press keys → and ↓ again. Old current range New current range Old value for error messages New value for error messages Measuring range with new data for the current output
→	Fct. 1.01	
4x ↑	Fct. 1.05	
→		
→ ↓		
→	04-20	
2x ↑	00-20	
↓		
→	0	
↑	22	
↓	Fct. 1.05	
↓	Fct. 1.00	
↓	-----	

5 Description of functions

5.1 Full-scale range $Q_{100\%}$

Fct. 1.01 FULL SCALE

Press → key.

Choice of unit for full-scale range $Q_{100\%}$

- **m³/hr** (cubic metres per hour)
- **Liter/Sec** (litres per second)
- **US.Gal/min** (US gallons per minute)
- User-defined unit, factory-set is „**Liter/hr**“ (litres per hour) or “**US MGal/day**”, see Sect. 5.13.

Select with ↑ key.

Use → key to transfer to numerical setting, 1st number (cursor) flashes.

Set full-scale range $Q_{100\%}$

The setting range is dependent on meter size (DN) and flow velocity (v).

$$Q_{\min} = \frac{\pi}{4} DN^2 \times v_{\min} \quad Q_{\max} = \frac{\pi}{4} DN^2 \times v_{\max} \quad (\text{refer to flow table in Sect. 10.1})$$

0.0053	–	33 929	m ³ /hr
0.00147	–	9 424.5	Liter/Sec
0.00233	–	151 778	US.Gal/min

Change flashing number (cursor) with ↑ key.

Use → key to shift cursor 1 place to right.

Press ↵ key to return to Fct. 1.01 FULL SCALE.

Note if “**VALUE P**” is displayed after pressing ↵ key:

PULSE/VOL. is set under Fct. 1.06 PULS B1, subfunction “SELECT P”. Due to the changed full-scale range $Q_{100\%}$, the output frequency (F) of the pulse output will be over- or undershot:

$$P_{\min} = F_{\min} / Q_{100\%} \quad P_{\max} = F_{\max} / Q_{100\%}$$

Change pulse value accordingly, see Sect. 5.7 pulse output B1, Fct. 1.06.

5.2 Time constant

Fct. 1.02 TIMECONST.

Press → key.

Choice

- **ALL** (applies to display and all outputs)
- **ONLY I** (applies only to display, current and status output)

Select with ↑.

Transfer to number setting with ↵ key. 1st number (cursor) flashes.

Set numerical value

- **0.2 - 99.9 Sec** (seconds)

Change flashing number (cursor) with the ↑ key.

Use → key to shift cursor 1 place to right.

Press ↵ key to return to Fct. 1.02 TIMECONST.

Fct. 1.03 L.F.CUTOFF

Press → key.

Choice

- **OFF** (fixed tripping point: ON = 0.1 % / OFF = 0.2 %)
- **PERCENT** (variable tripping points: ON = 1 - 19 % / OFF = 2 - 20 %)

Select with ↑ key.

Transfer to number setting using → key (only if “PERCENT” selected).

1st number (cursor) flashes.

Setting the numerical value when “PERCENT” selected

- **01 to 19** (cutoff “on” value, left of hyphen)
- **02 to 20** (cutoff “off” value, right of hyphen)

Change flashing number (cursor) with the ↑ key.

Shift cursor 1 place to right using → key.

Press ↵ key to return to Fct. 1.03 L.F.CUTOFF.

Note: The cutoff “off” value must be greater than the cutoff “on” value.

Fct. 1.04 DISPLAY

Press → key.

→ **DISP. FLOW = select unit for display of flowrate, press → key**

- **NO DISP.** (no display)
- **m3/hr** (cubic metres per hour)
- **Liter/Sec** (litres per second)
- **US.Gal/min** (US gallons per minute)
- user-defined unit, factory-set: “**Liter/hr**” (litres per hour) or “**US MGal/day**”, see Sect. 5.15
- **PERCENT** (percentage display)
- **BARGRAPH** (numerical value and bar graph display in %)

Select with ↑ key.

Press ↵ key to transfer to subfunction “DISP. TOTAL”.

→ **DISP. TOTAL = select unit for totalizer display, press → key**

- **NO DISP.** (no display)
- **OFF** (internal totalizer switched off)
- **+ TOTAL.** • **- TOTAL.** • **+/- TOTAL.** • **SUM (Σ)** • **ALL (sequential)**

Select with ↑ key.

Transfer to totalizer unit setting using ↵ key.

- **m3** (cubic metres)
- **Liter** (litres)
- **US.Gal** (US gallons)
- user-defined unit, factory-set: “**Liter**” or “**US MGal**”, see Sect. 5.12

Select with ↑ key.

Transfer to totalizer format setting using → key.

Setting of totalizer format

- **Auto** (exponent notation)
- # . ##### • ##### . ###
- ## . ##### • ##### . ##
- ### . ##### • ##### . #
- #### . ##### • #####

Select with key ↑.

Press ↵ key to transfer to subfunction “DISP. MSG”.

→ **DISP. MSG. = additional messages required in measuring mode, press → key**

- **NO** (no other messages)
- **YES** (display other messages, e.g. errors, in sequence with the measured values)

Select using the ↑ key.

Press ↵ key to return to Fct. 1.04 DISPLAY.

Note: “BUSY” is displayed in the measuring mode when all displays are set to “NO DISP.” or “NO”. Sequencing of displays is automatic. However, in the measuring mode, manual sequencing can be carried out with the ↑ key. Return to automatic sequencing after approx. 3 minutes.

Please refer to Sect. 3.2 “factory settings”

5.5 Internal electronic totalizer

The internal electronic totalizer counts in m³, regardless of the unit set under Fct. 1.04, subfunction “DISP. FLOW”.

The counting range is dependent upon the meter size and has been selected such that the totalizer will count for a minimum of 1 year without overflow:

Meter size		Counting range	
DN mm	inch	in m ³	US Gal equivalent
10 - 50	³ / ₈ - 2	0 - 999 999.9999999	0 - 264 172 052.35800
65 - 200	2 ¹ / ₂ - 8	0 - 9 999 999.9999999	0 - 2 641 720 523.5800
250 - 600	10 - 24	0 - 99 999 999.999999	0 - 26 417 205 235.800
700 -1000	28 - 40	0 - 999 999 999.99999	0 - 264 172 052 358.00

Only part of the totalizer count is shown in the display because it is not possible to output a 14-digit number. Unit and format of the display are freely selectable, see Fct. 1.04, subfunction “DISP. TOTAL” and Sect. 5.4. This determines which part of the count is to be displayed. Display overflow and totalizer overflow are independent of one another.

Example

Internal count	0000123 . 7654321	m ³
Format, display unit	XXXX . XXXX	Liter
Internal count in unit	0123765 . 4321000	Liter
Displayed	3765 . 4321	Liter

Fct. 1.05 CURRENT I

Press → key.

→ **FUNCT. I = Select function for current output, press → key**

- **OFF** (switched off, no function)
- **1 DIR.** (1 flow direction)
- **2 DIR.** (2 flow directions, F/R mode, forward/reverse)

Select using ↑ key.

Transfer to *subfunction* "RANGE I" with ↓ key.

Exceptions: When "OFF" selected, return to Fct. 1.05 CURRENT I.

When "2 DIR." selected, transfer to *subfunction* "REV.RANGE".

→ **REV.RANGE = define full-scale range for reverse flow**

(appears only when "2 DIR." set under "FUNCT. I" above)

Press → key

- **100 PCT.** (same full-scale value $Q_{100\%}$ as forward flow, see Fct. 1.01)
- **PERCENT** (settable range) Setting range 005 – 150% of $Q_{100\%}$ (see Fct. 1.01)

Select with ↑ key.

Press → key to transfer to number setting.

Press ↓ key to transfer to subfunction "RANGE I".

→ **RANGE I = select measuring range, press → key**

- **0 - 20 mA** } fixed ranges
- **4 - 20 mA** }
- **mA** (user-defined value) $\frac{I_{0\%} - I_{100\%}}{0-16 \text{ mA} \quad 4-20 \text{ mA}}$
(value $I_{0\%} < I_{100\%}$!)

Press → key to transfer to number setting.

Select with key ↑.

Press key ↓ to transfer to *subfunction* "I ERROR".

→ **I ERROR = set error value, press → key**

- **22 mA** (fixed value)
- **0.0 - $I_{0\%}$ mA** (variable value; only variable when $I_{0\%} \geq 1 \text{ mA}$, see "RANGE I" above)

Select using key ↑. Press → key to transfer to number setting.

Press key ↓ to return to Fct. 1.05 CURRENT I.

Please refer to Sect. 3.2 "Factory settings".

Refer to Sect. 2.6 for connection diagrams, and to Sect. 5.15 for characteristics.

5.7 Pulse output B1

NOTE! Check whether under Fct. 3.07 "HARDWARE" the output terminal "B1" is defined as pulse output, refer also to Sect. 2.2 and Sect. 5.16.

Fct. 1.06 PULS B1

Press key → .

→ **FUNCT. P = select function for pulse output**, *press* → *key*

- **OFF** (switched off, no function)
- **1 DIR.** (1 flow direction)
- **2 DIR.** (2 flow directions, F/R mode, forward/reverse)

Select with key ↑.

Press ↓ key to transfer to *subfunction* "SELECT P".

Exception: When "OFF" selected, return to Fct. 1.06 PULS B1.

→ **SELECT P = select pulse type**, *press* → *key*

- **PULSE/VOL.** (pulses per unit volume, flowrate)
- **PULSE/TIME** (pulses per unit time for 100% flowrate)

Select with key ↑.

Press ↓ key to return to *subfunction* "PULSWIDTH".

→ **PULSWIDTH = select pulse width**, *press key* →

- **AUTO** (automatic = 50% of the period length of the 100% output frequency)
- **SYM.** (symmetrical = 1:1 pulse duty ratio over entire range)
- **SEC.** (variable) setting range 0.01 - 1.00 SEC

Select with key ↑.

Press → key to transfer to *number setting*.

1st number (cursor) flashes. Set numbers using keys ↑ and →.

Press ↓ key to transfer to *subfunction* "VALUE P" or return to Fct. 1.06 PULS B1, depending on choice of pulse type in *subfunction* "SELECT P".

Please note

$$F_{\min} = 10 \text{ pulses/h}$$

$$F_{\max} = \frac{1}{2 \times \text{pulse width [s]}}$$

If "AUTO" or "SYM." is selected under *subfunction* "PULSWIDTH"

$$F_{\max} \leq 1 \text{ kHz !}$$

→ **VALUE P = set pulse value per unit volume**

(appears only when "PULSE/VOL." set under "SELECT P", press → key.

- **XXXX PulS/m³**
- **XXXX PulS/Liter**
- **XXXX PulS/US.Gal**
- **XXXX PulS/** user unit, factory-set: "**Liter**" or "**US MGal**", see Sect. 5.13.

Select using ↑ key.

Transfer to number setting with → key. 1st digit (cursor) flashes.

Set numerical value

- **XXXX** (setting range depends on pulse width and full-scale range: $P_{\min} = F_{\min} / Q_{100\%}$ $P_{\max} = F_{\max} / Q_{100\%}$)

Change flashing digit (cursor) with ↑ key,

shift cursor 1 place to right or left with → key.

Press ↵ key to return to Fct. 1.06 PULS B1.

or

→ **VALUE P = set pulse value per unit time,**

(appears only when "PULSE/TIME" has been set under "SELECT P"), press → key.

- **XXXX PulSe/Sec**
- **XXXX PulSe/min**
- **XXXX PulSe/hr**
- **XXXX PulSe/** user unit, factory-set: "**hr**", or "**day**", see Sect. 5.13.

Select using ↑ key.

Transfer to number setting with → key, 1st digit (cursor) flashes.

Set numerical value

- **XXXX** (setting range depends on pulse width)

Change flashing digit (cursor) with ↑ key,

shift cursor 1 place to right or left with → key.

Press ↵ key to return to Fct. 1.06 PULS B1.

Please refer to Sect. 3.2 "factory settings"

Refer to Sect. 2.6 for connection diagrams, and to Sect. 5.15 for characteristics.

5.8 Status outputs B1 and B2

NOTE: Check whether under Fct. 3.07 "HARDWARE" the output terminal "B1" and/or "B2" is defined as status output B1 and/or B2, refer also to Sect. 2.1 and Sect. 5.16.

Fct. 1.06 and/or 1.07 STATUS B1 and/or B2

Press key → .

Select function of status outputs, *press* → *key*

- **ALL ERROR** (indicates all errors)
- **FATAL.ERROR** (indicates fatal errors only)
- **OFF** (switched off, no function)
- **ON** (indicates that flowmeter is operative)
- **SIGN. I** } V/R mode } *Dynamic response*
- **SIGN. P** } } of outputs, see Fct. 1.02, Sect. 5.2 "time constant"
- **OVERFLOW I** } overranging } **I = I ONLY**
- **OVERFLOW P** } of outputs } **P = ALL**
- **EMPTY PIPE** (option "empty tube identification")

- **AUTO RANGE** (automatic range change) Setting range 5-80 PERCENT
(= ratio of upper to lower range, 1:20 to 1:1.25, value must be greater than that of Fct. 1.03 "L.F.CUTOFF", see also Sect. 5.18)

- **TRIP POINT** (define trip point) see also Sect. 5.17.

XXX	-	YYY	N/O contact: XXX > YYY
0 - 150%		0 - 150%	N/C contact: XXX < YYY
			Hysteresis: difference between XXX and YYY.

Press ↓ key to transfer to number setting, 1st digit (cursor) flashes.

Change flashing digit (cursor) with key ↑. Use key → to shift cursor 1 place to right.

Press ↓ key to return to Fct. 1.06 and/or 1.07 STATUS B1 or B2.

• Characteristics of status outputs	Switch open	Switch closed
OFF (switched off)	no function	
ON (e.g. operation indicator)	power OFF	power ON
SIGN I (F/R mode)	Forward flow	Reverse flow
SIGN P (F/R mode)	Forward flow	Reverse flow
TRIP POINT (limit switch)	inactive	active
AUTO RANGE (automatic range change)	high range	low range
OVERFLOW I (I overranged)	current output OK	current output overranged
OVERFLOW P (P overranged)	pulse output OK	pulse output overranged
ALL ERROR (all errors)	errors	no error
FATAL.ERROR (fatal errors only)	errors	no error
EMPTY PIPE (option)	when measuring tube is empty	when measuring tube is full

Please refer to Sect. 3.2 "factory settings".

Connection diagrams, see Sect. 2.6.

NOTE! Check whether under Fct. 3.07 "HARDWARE" the output terminal "B1" and/or "B2" is defined as control input B1 and/or B2, refer also to Sect. 2.1 and Sect. 5.16.

Fct. 1.06 and 1.07 CONTROL B1/B2

Press key → twice.

Select function of control inputs, press key ↑.

- **OFF** (switched off, no function)
 - **OUTP. HOLD** (hold value of outputs)
 - **OUTP. ZERO** (set outputs to "min. values")
 - **TOTAL. RESET** (reset totalizers)
 - **ERROR. RESET** (delete/acknowledge error messages)
 - **EXT. RANGE** (external range change for automatic range change, see also Sect. 5.19, setting range 5 – 80 PERCENT = ratio of low to high range 1:20 to 1:1.25, value must be greater than that of Fct. 1.03 L.F.CUTOFF)
- } Functions also act on display and totalizer

Press ↓ key to transfer to number setting, 1st digit (cursor) flashes.
Change flashing digit with key ↑,
press key → to shift cursor 1 place to the right.

Press ↓ key to return to Fct. 1.06 or 1.07 CONTROL B1 or B2.

Please refer to Sect. 3.2 "factory settings".

Connection diagram, see Sect. 2.6.

Fct. 3.01 LANGUAGE

Press → key.

Select language for texts in display

- **D** (German)
- **GB/USA** (English)
- **F** (French)
- **others** on request

Select using ↑ key.

Press ↓ key to return to Fct. 3.01 LANGUAGE.

Fct. 3.04 ENTRY CODE

Press → key.

Choice

- **NO** (no code, enter setting mode with → key)
- **YES** (enter setting mode with → key and Code 1: → → → ↓ ↓ ↓ ↑ ↑ ↑)

Select using ↑ key.

Press ↓ key to return to Fct. 3.04 ENTRY CODE.

5.12 Primary head

Fct. 3.02 FLOW METER

Press → key.

→ **DIAMETER = set meter size** (see instrument nameplate), *press* → *key*

Select size from table of meter sizes:

- DN 2.5 - 1000 mm equivalent to 1/10 - 40 inch

Select using ↑ key.

Transfer to subfunction "FULL SCALE" with ↵ key.

→ **FULL SCALE = set full-scale range**, *press* → *key*.

Set as described in Sect. 5.1.

Transfer to subfunction "GK VALUE" with ↵ key.

Note: if "VALUE P" is displayed after pressing ↵ key.

PULSE/VOL. is set under Fct. 1.06 PULS B1, subfunction "SELECT P". Because the full-scale range $Q_{100\%}$ has been changed, the output frequency (F) of the pulse output is over- or undershot:

$$P_{\min} = F_{\min} / Q_{100\%} \quad P_{\max} = F_{\max} / Q_{100\%}$$

Change pulse value accordingly, see Sect. 5.7 pulse output B1, Fct. 1.06.

→ **GK VALUE = set primary constant GK**, *press* → *key*.

- 1.0000 - 9.9999 (note information on instrument nameplate, do not change setting !)

Change flashing digit (cursor) with ↑ key.

Shift cursor 1 place to right or left with → key.

Transfer to subfunction "FIELD FREQ." with ↵ key.

→ **FIELD FREQ. = set magnetic field frequency**, *press* → *key*

- 1/2 • 1/6 (1/2, 1/6, 1/18 and 1/36 of power frequency, see instrument nameplate,
- 1/18 • 1/36 do not change setting, exceptions see Sect. 6.4-6.6 !)

Select using ↑ key.

Transfer to subfunction "FLOW DIR." with ↵ key.

(only for units with DC power supply, transfer to subfunction "LINE FREQ").

→ **LINE FREQ. = normal line frequency in your country**, *press* → *key*.

- 50 Hz Select using the ↑ key.
- 60 Hz Transfer to subfunction "FLOW DIR." with ↵ key.

→ **FLOW DIR. = set flow direction**, *press* → *key*.

- + DIR. (for identification of flow direction, see "+" arrow on primary head;
- - DIR. for F/R mode, identifies the "positive" flow direction)

Select using the ↑ key.

Press ↵ key to return to Fct. 3.02 FLOW METER.

Zero check, see Fct. 3.03 and Sect. 7.1.

Please refer to Sect. 3.2 "factory settings"

Fct. 3.05 USER UNIT

Press → key.

→ **TEXT VOL = set text for user-defined unit, press → key**

- **Liter** (max. 5 characters, factory-set: "Liter" or "US MGal")
Characters assignable to each place: **A-Z, a-z, 0-9**, or "-" (= blank character)

Change flashing place (cursor) using ↑ key.

Use → key to shift cursor 1 place to right.

Transfer to subfunction "FACT. VOL." with ↵ key.

→ **FACT. VOL. = set factor F_M for volume, press → key**

- **1.00000 E+3** (factory-set: "10³ or 2.64172 x 10⁻⁴" / factor F_M = volume per 1 m³)
Setting range: 1.00000 E-9 to 9.99999 E+9 (= 10⁻⁹ to 10⁺⁹)

Change flashing place (cursor) using ↑ key.

Use → key to shift cursor 1 place to right.

Transfer to subfunction "TEXT TIME" with ↵ key.

→ **TEXT TIME = set text for required time, press → key**

- **hr** (max. 3 places, factory-set: "hr = hour" or "day")
Characters assignable to each place: **A-Z, a-z, 0-9**, or "-" (= blank character)

Change flashing place (cursor) using ↑ key.

Use → key to shift cursor 1 place to right.

Transfer to subfunction "FACT. TIME" with ↵ key.

→ **FACT. TIME = set factor F_T for time, press → key**

- **3.60000 E+3** (factory-set: "3.6 x 10³" for hour or "8.64 x 10⁴" for day / set factor F_T in seconds)
Setting range: 1.00000 E-9 to 9.99999 E+9 (= 10⁻⁹ to 10⁺⁹)

Change flashing place (cursor) using ↑ key.

Use → key to shift cursor 1 place to right.

Press ↵ key to return to Fct. 3.05 USER UNIT.

Factors for volume F_M (factor F_M = volume per 1 m³)

Volumetric unit	Text examples	Factor F _M	Setting
Cubic metres	m3	1.0	1.00000 E+0
Litres	Liter	1 000	1.00000 E+3
Hectolitres	h Lit	10	1.00000 E+1
Decilitres	d Lit	10 000	1.00000 E+4
Centilitres	c Lit	100 000	1.00000 E+5
Millilitres	m Lit	1 000 000	1.00000 E+6
US gallons	USGal	264.172	2.64172 E+2
Millions US gallons	USMG	0.000264172	2.64172 E-4
Imperial gallons	GBGal	219.969	2.19969 E+2
Mega imperial gallons	GBMG	0.000219969	2.19969 E-4
Cubic feet	Feet3	35.3146	3.53146 E+1
Cubic inches	inch3	61 024.0	6.10240 E+4
US barrels liquid	US BaL	8.36364	8.38364 E+0
US barrels ounces	US BaO	33 813.5	3.38135 E+4

Factors for time F_T (factor F_T in seconds)

Time unit	Text examples	Factor F _T (seconds)	Setting
Seconds	Sec	1	1.00000 E+0
Minutes	min	60	6.00000 E+1
Hours	hr	3 600	3.60000 E+3
Day	DAY	86 400	8.64000 E+4
Year (= 365 days)	YR	31 536 000	3.15360 E+7

5.14 F/R mode, forward/reverse flow measurement

- Refer to Sect. 2.6 for electrical connection of outputs.
- Define direction of forward (normal) flow, see Fct. 3.02, subfunction "FLOW DIR.": in conjunction with F/R operation, set the direction for the forward flow here. "+" signifies the same direction as shown by the arrow on the primary head, "-" signifies the opposite direction.
- Set the status output to "SIGN I" or "SIGN P", see Fct. 1.06 or 1.07, "STATUS B1 or B2". For dynamic response of the outputs with "SIGN I" or "SIGN P" see Sect. 5.8.
- Current and/or pulse output must be set to "2 DIR.", see Fct. 1.05 and 1.06, subfunctions "FUNCT. I" and "FUNCT. B1".

5.15 Characteristic of outputs

I Current output

I_{0%} 0 or 4 mA

I_{100%} 20 mA

P Pulse output

P_{100%} Pulses at Q_{100%}, full-scale range

Q_F 1 flow direction, forward flow in F/R operation

Q_R Reverse flow in F/R operation

Q_{100%} Full-scale range

S Status output B1 or B2

 switch open

 switch closed

1 flow direction

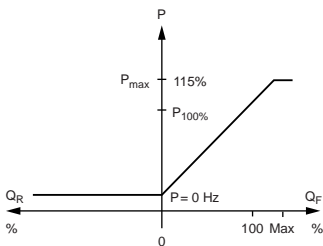
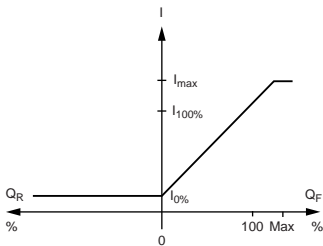

2 flow directions, F/R operation

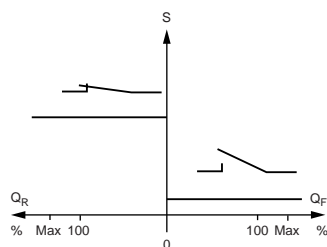
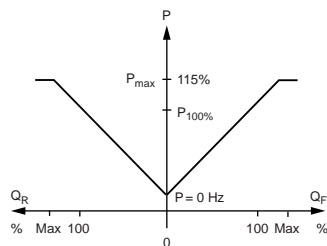
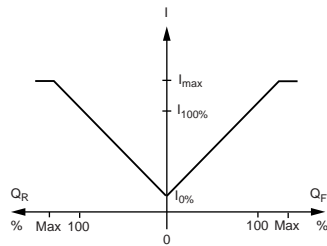

Fct. 3.07 HARDWARE

Press → key.

Define function of terminal B1, press key →

- **PULSOUTP.** (= pulse output)
 - **STATUSOUTP.** (= status output)
 - **CONTROLINP.** (= control input)
- } Select with key ↑,
press key ↓ to advance to
terminal B2.

Define function of terminal B2, press key →

- **STATUSOUTP.** (status output)
 - **CONTROLINP.** (control input)
- } Select with key ↑.

Press key ↓ to return to Fct. 3.07 HARDWARE.

Please note: If, for example, both output terminals (B1 and B2) are set to status output, or to control input, their operating modes can only be selected **once**.

Example: B1 and B2 are status outputs.

If status output B1 is used for the automatic range change BA, this operating mode is not available for status output B2.

Fct. 1.06 or 1.07 status outputs B1 or B2

(Define operating mode of output terminals, see Sect. 5.16)

Press key → .

Set status output B1 or B2 to "TRIP POINT" by pressing key ↑ (1 to 9 times).

Press ↓ key to transfer to number setting, 1st digit (cursor) flashes.

Change flashing digit with key ↑, use key → to shift cursor 1 place to the right.

- **Display XXX – YYY**
- **Setting ranges:** XXX value = 0 – 150% of $Q_{100\%}$
YYY value = 0 – 150% of $Q_{100\%}$
Hysteresis ≥ 1% (= difference between XXX and YYY values)
- **Switching performance** (N/O or N/C contact) can be set.

N/O contact XXX value > YYY value

Contact **closes**

when flowrate **greater than** XXX value

Example: XXX = 55%
YYY = 45%
Hysteresis = 10%

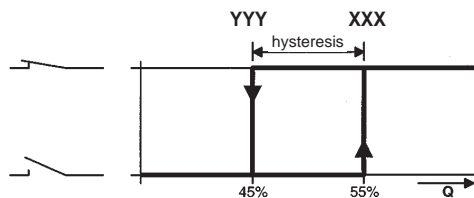

N/C contact XXX value < YYY value

Contact **opens**

when flowrate **greater than** YYY value

Example: XXX = 45%
YYY = 55%
Hysteresis = 10%

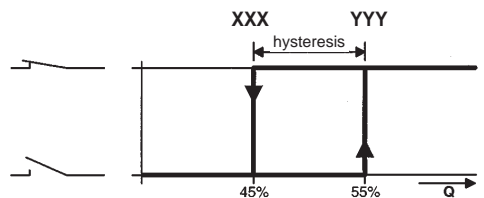

Note: When the two status outputs B1 and B2 are activated (see Sect. 5.16), **min. and max. values** can, for example, be signalled. The limit switches are active only in the case of forward flow.

5.18 Automatic range change BA

Automatic range change by means of status output

Fct. 1.06 or 1.07 status output B1 or B2

(Define operating mode of output terminals, see Sect. 5.16)

Press key → .

Set status output B1 or B2 to automatic range change "AUTO RANGE" by pressing key ↑ (1 to 9 times).

Press key ↓ to transfer to number setting, 1st digit (cursor) flashes.
Change flashing digit with key ↑, use key → to shift cursor 1 place to the right.

Setting range: 5 – 80 PERCENT of $Q_{100\%}$ (= ratio between low and high range
1 : 20 to 1 : 1.25)

Press key ↓ to return to Fct. 1.06 or 1.07 status output B1 or B2.

External range change by means of control input

Fct. 1.06 or 1.07 control inputs B1 or B2

(Define operating mode of output terminals, see Sect. 5.16)

Press key → .

Set control inputs B1 or B2 to range change "EXT.RANGE" by pressing key ↑ (1 to 5 times).

Press key ↓ to transfer to number setting, 1st digit (cursor) flashes.
Change flashing digit with key ↑, use key → to shift cursor 1 place to the right.

Setting range: 5 – 80 PERCENT of $Q_{100\%}$ (= ratio between low and high range
1 : 20 to 1 : 1.25)

Press key ↓, to return to Fct. 1.06 or 1.07 control input B1 or B2.

Fct. 3.07 APPLICAT.

Press key → .

Set characterization for the flow, press key → .

- **STEADY** (flow is steady)
 - **PULSATING** (pulsating flow, e.g. due to reciprocating pumps, see also Sect. 6.4, 6.5 and 6.6 "Special-case applications")
- } select function with ↑ key

Press ↓ key to return to Fct. 3.07 APPLICAT.

With built-in option "empty tube identification" change to subfunction "EMPTY PIPE"

→ **EMPTY PIPE**, "function switch on"

- **YES** • **NO** select with ↑ key.

Press ↓ key to return to Fct. 3.07 APPLICAT.

Part C Special applications, functional checks, service, and order numbers

6 Special applications

6.1 Use in hazardous areas

Electromagnetic flowmeters with IFC 090 signal converter are approved as electrical equipment in conformity with the harmonized European Standards and Factory Mutual (FM).

Correspondence between the temperature classes and the temperature of the process liquid, meter size and material of the measuring tube liner is defined in the test certificate.

Test certificate, certificate of conformity and wiring instructions are attached to the Installation and Operating Instructions (applies only to hazardous-duty equipment).

6.2 RS 232 adapter incl. CONFIG software (options)

Operator control can be carried out externally with MS-DOS PC via an RS 232 adapter incl. CONFIG software

The Basic Version (IFC 090 __ / **B**) and the Display Version (IFC 090 __ / **D**) of the signal converter can be operated with this option. Detailed instructions are supplied.

Always switch off power source before opening the housing !

- 1) Unscrew the cover from the electronic compartment using the special wrench.
- 2) If provided, remove the display unit. For this purpose, detach the two screws **R** and fold display unit to the side, see illustration in Sect. 8.5.
- 3) Insert the RS 232 adapter (forming the connection to the PC or laptop) into the IMoCom bus plug connector **X2**; for amplifier PCB, refer to Sect. 8.9.
- 4) Switch on the power.
- 5) As described in the supplied instructions, change data, parameters and measured values or have them called up for display.
- 6) Switch off the power.
- 7) Pull off the RS 232 adapter from the amplifier PCB.
- 8) Secure the display unit with screws **R**.
- 9) Replace and tighten down the cover on the electronic compartment using the special wrench.

NOTE: The screw thread and gasket of the housing cover should be well greased at all times, always check for signs of damage and never allow dirt to accumulate. Replace defective gasket immediately.

Please refer to Sect. 3.2 "Factory settings"

Output signals can be stabilized to values as for “zero” flow to prevent random output signals when the measuring tube is empty or when the electrodes are not wetted in the event the measuring tube is partially full.

- Display: 0
- Current output: 0 or 4 mA, see setting in Fct. 1.05
- Pulse output: no pulses (= 0 Hz), see setting in Fct. 1.06

Precondition: electrical conductivity of product: $\geq 200 \mu\text{S/cm}$,
 $\geq 500 \mu\text{S/cm}$ for meter sizes DN 2.5 - 15 and $1/10'' - 1/2''$

Changes on amplifier PCB, see illustration in Sect. 8.9.

Switch off power source before opening the housing!

- 1) Unscrew cover from the terminal compartment using the special wrench. Pull off the two plugs for supply power (3-pin) and outputs/inputs (6-pin).
- 2) Unscrew cover from the electronic compartment using the special wrench.
- 3) If provided, remove display unit. For this purpose, detach the two screws **R** and fold display unit to the side, see illustration in Sect. 8.5.
- 4) Carefully pull off the blue 9-pin plug **X1/X4** (forming the connection to the primary head).
- 5) Detach the 2 recessed head screws **Q** and carefully remove the electronic unit.
- 6) Join the two “semicircles” of points **S1** and **S3** on the amplifier board with tin solder, see illustration in Sect. 8.9.
- 7) Reassemble in reverse order, points 5) - 2) above.
- 8) Switch on power.
- 9) Check setting of the low-flow cutoff SMU, Fct. 1.03, and reset if necessary:

L.F.CUTOFF switched on, range:		Full scale range $Q_{100\%}$		Cutoff values	
				... OFF ON ...
> 3 m/s	> 10 ft/s	> 2 %	1 %		
1 - 3 m/s	3 - 10 ft/s	> 6 %	4 %		
< 1 m/s	< 3 ft/s	>10 %	8 %		

Operator control:

Display Version: IFC 090 __ / **D**, see Sect. 4 and 5.3, Fct. 1.03

Basic Version: IFC 090 __ / **B**, see Sect. 6.2.

- 10) After checking and/or resetting, replace the cover on the electronic compartment and tighten using the special wrench.
NOTE: The screw thread and gasket of the housing cover should be well greased at all times, always check for signs of damage and never allow dirt to accumulate. Replace defective gasket immediately.

6.4 Pulsating flow

Application

downstream of positive-displacement pumps (reciprocating or diaphragm pumps) without pulsation dampener

Operator control of the signal converter for the new settings

IFC 090 **B** (basic version) see Sect. 6.2

IFC 090 **D** (display version) see Sect. 4 and 5

To change settings

- Fct. 3.02 FIELD FREQ. (change magnetic field frequency)
 - Stroke frequency **less than 80 strokes/min** (at max. pump lift): do **not** change setting.
 - Stroke frequency **80 - 200 strokes/min** (at max. pump lift): change setting to **1/2**, only practical with IFM 5080 K and IFS 5000 F (DN 2.5-100 / 1/10"-4") and IFM 4080 K and F IFS 4000 F (DN 10, 15, 50-100 / 1/10", 1/2", 2"-4"), Please consult factory where other types and meter sizes are concerned.
 - Please note: given stroke frequencies close to the tripping point of 80 strokes/min, additional measuring errors of approx. ± 0.5% of the measured value may occasionally occur.
- Fct. 3.06 APPLICAT. (adjust overload point of the A/D converter to the application)
Change setting to "PULSATING".
- Fct. 1.04 DISP. FLOW (change display presentation of flow)
Change setting to "BARGRAPH" to allow better assessment of display unsteadiness.
- Fct. 1.02 TIMECONST. (change time constant)
 - Set to "ALL" and time (t) in seconds.

– Recommended:
$$t [s] = \frac{1000}{\text{min. strokes} / \text{min}}$$

– Example: min. number of strokes in operation = 50 strokes/minute

$$t [s] = \frac{1000}{50 / \text{min}} = 20 \text{ s}$$

With this setting, the residual ripple of the display will amount to approx. ± 2% of the measured value. Doubling the time constant will reduce the residual ripple by a factor of 2.

6.5 Rapid changes in flowrate

Application

in conjunction with batching processes, fast-response control loops, etc.

Operator control of the signal converter for the new settings

IFC 090 **B** (basic version) see Sect. 6.2

IFC 090 **D** (display version) see Sect. 4 and 5

To change settings

- Fct. 1.02 TIMECONST. (change time constant)
Setting to "ONLY I" and set time to 0.2 s.
- Dynamic response with meter sizes DN 2.5-300 / 1/10"-12"
Dead time: approx. 0.06 s at 50 Hz line frequency
approx. 0.05 s at 60 Hz line frequency
Time constant: set as above, current output (mA) additionally plus 0.1 s
- Reducing the dead time by a factor of 3 (possible by changing the magnetic field frequency)
Fct. 3.02 FLOW METER, subfunction "FIELD FREQ.", change to "1/2", only practical with IFM 5080 K and IFS 5000 F (DN 2.5-100 / 1/10"-4") and IFM 4080 K and IFS 4000 F (DN 10, 15, 50-100 / 1/10", 1/2", 2"-4")
Please consult factory where other types and meter sizes are concerned.

Unsteady display and outputs can occur in connection with

- high solids contents,
- non-homogeneity,
- poor blending, or
- chemical reactions still in progress in the process liquid.

If, in addition, flow is also pulsating due to the use of diaphragm or reciprocating pumps, refer to Sect. 6.4.

Operator control of the signal converter for the new settings

IFC 090 **B** (basic version) see Sect. 6.2

IFC 090 **D** (display version) see Sect. 4 and 5

To change settings

- Fct. 1.04 DISP. FLOW (change display presentation of the flow)
Change setting to "BARGRAPH" to allow better assessment of display unsteadiness.
- Fct. 1.02 TIMECONST. (change time constant)
 - Setting to "ONLY I", to "ALL" if pulse output too unsteady.
 - Set time constant to approx. "20 s", observe unsteadiness of display and adjust time constant if necessary.
- Fct. 3.06 APPLICAT. (adjust overload point of the A/D converter to the application)
Set to "PULSATING" on trial basis, if unsuccessful return to "STEADY".
- Fct. 3.02 FIELD FREQ. (change magnetic field frequency)
On trial basis, change setting to "1/2"; if unsuccessful return to previous setting, usually "1/6".

Only practical with IFM 5080 K and IFS 5000 F (DN 2.5-100 / 1/10"-4")
and IFM 4080 K and IFS 4000 F (DN 10, 15, 50-100 / 1/10", 1/2", 2"-4"),
Consult factory where other types and meter sizes are concerned.

HART® interface

The HART interface is a smart interface, in other words a communication signal superimposed on the current output. All functions and parameters can be accessed via this interface.

The following HART features are supported by the IFC 090 signal converter:

- point-to-point connection
- multidrop (up to 15 HART devices)

The burst mode is not normally used and is therefore not supported. Further information about HART is available from the HART Communication Foundation, of which Krohne is a member.

Electrical connection

HART connection active

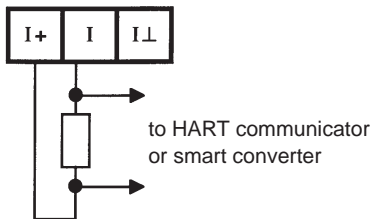

HART connection passive

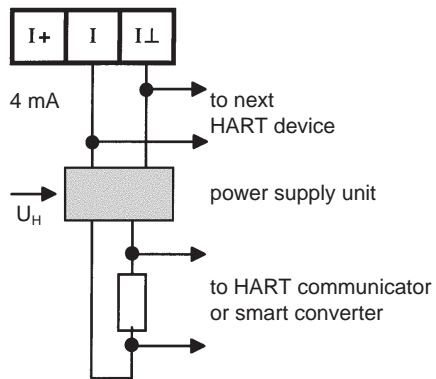

Factory setting for the point-to-point mode with HART

- In Menu 1.05, the “FUNCT.I” parameter must be set to “1 DIR”. or “2 DIR.”.
- **IMPORTANT:** In Menu 1.05, the “RANGE I” parameter must be set to “4-20 mA”, or, in the case of variable setting, the value for “I_{0%}” must be at least 4 mA.
- In Menu 3.09, the “COM1” parameter must be set to “HART” and the “ADDRESS” parameter to “0”.
- The current output may be operated in the active or passive mode.

Factory setting for the multidrop mode with HART

- In Menu 1.05, the “FUNCT.I” parameter must be set to “OFF”.
- In Menu 3.09, the “COM1” parameter must be set to “HART” and the “ADDRESS” parameter to a value of “1-15”. This address may only be set for one device in the HART multidrop network.
- **IMPORTANT:** the current output may only be operated in the passive mode.

Minimum load impedance

A minimum load impedance of 250 Ω is required to enable the HART signals to be modulated on the current output. Series-connect an appropriate resistor if the devices located in the current output circuit should not attain this value. It will then be possible via the minimum load impedance e.g. to connect the HART communicator or smart converter in parallel without interrupting the current output. Please note that the load impedance should not exceed a maximum of 500 Ω .

HART operating tools / DD

The IFC 090 can be operated either via its local operator interface or by means of the HART communicator or the CONFIG program. Both operating tools are available from KROHNE. Operator control by means of the HART communicator requires a device description (DD) which we can load for you into the communicator. We can, of course, also load the DDs of all manufacturers who have filed their DDs with the HART Communication Foundation. If you wish to use the IFC 090 in your operating tool, for example, please ask for the description of the HART command used so that you can address the complete IFC 090 functionality via HART.

In the near future we shall also be supporting the ASM tool from Rosemount and the SIPROM tool from Siemens.

Power supply units / isolation switching amplifiers

You will need an appropriate power supply unit if the current output is to operate in the passive mode. Please ensure that this power supply unit is also suitable for HART communication. This applies equally to isolation switching amplifiers that are sometimes used in the active mode.

Additional functions for HART version

Fct.	Text	Description and settings
3.08	LOCATION	Set any tag name (max. 10 characters) Characters assignable to each place: <ul style="list-style-type: none">• A - Z, a - z, 0 - 9, or " - " (= blank character) Press \downarrow key to transfer to Fct. 3.08 "LOCATION".
3.09	COM	HART communications-interface <ul style="list-style-type: none">• OFF (switched off)• HART (switched on) } Select with \uparrow key. Press \downarrow key, set "ADDRESS" with \uparrow and \rightarrow keys, Range: 001 - 015 Press \downarrow key to transfer to Fct. 3.09 "COM".

7. Functional checks

7.1 Zero check with IFC 090 ___ / D signal converter, Fct. 3.03

Switch off power source before opening the housing

- Set “zero” flow in the pipeline, but make sure that the measuring tube is completely filled with fluid.
- Switch on the system and wait 15 minutes.
- Press the following keys for zero measurement:

Key	Display		Description
→			If “YES” set under Fct. 3.04 ENTRY CODE, key in 9-keystroke CODE 1 now: → → → ↵ ↵ ↵ ↑ ↑ ↑
2x ↑	Fct. 1.00	OPERATION	
→	Fct. 3.00	INSTALL.	
→	Fct. 3.01	LANGUAGE	
2x ↑	Fct. 3.03	ZERO SET	
→		CALIB. NO	
↑		CALIB. YES	
↵	0.00	----- / ---	Flowrate displayed in set unit, see Fct. 1.04 DISPLAY, subfunction “DISP. FLOW”.
		STORE NO	Zero measurement in progress, duration approx. 50 seconds. When flow “> 0” “WARNING” notice appears, confirm with ↵ key. If new value not to be stored, press ↵ key (3x) 4x = return to measuring mode.
↑		STORE YES	
↵	Fct. 3.03	ZERO SET	Store new zero value.
(2x) 3x ↵	-----	----- / ---	Measuring mode with new zero.

7.2 Test of measuring range Q, Fct. 2.01

Switch off power source before opening the housing !

- For this test a measured value can be simulated in the range of -110 to +110 percent of $Q_{100\%}$ (full-scale range set, see Fct. 1.01 FULL SCALE).
- Switch on the system.
- Press the following keys for this test:

Key	Display		Description
→			If “YES” set under Fct. 3.04 ENTRY CODE, key in 9-keystroke CODE 1 now: → → → ↵ ↵ ↵ ↑ ↑ ↑
↑	Fct. 1.00	OPERATION	
→	Fct. 2.00	TEST	
→	Fct. 2.01	TEST Q	
→		SURE NO	
↑		SURE YES	
↵	0	PERCENT	Current, pulse and status indication outputs indicate the corresponding values.
↑	± 10	PERCENT	
	± 50	PERCENT	Select using ↑ key
	± 100	PERCENT	
	± 110	PERCENT	
↵	Fct. 2.01	TEST Q	End of test, actual measured values again present at outputs.
(2x) 3x ↵	-----	----- / ---	Measuring mode

Switch off power source before opening the housing !

- Before consulting factory about errors or flow measurement problems, please invoke Fct. 2.02 HARDW. INFO (hardware information).
- An 8-character and a 10-character status code are stored under this function in each of 3 "windows". These 6 status codes allow rapid and simple diagnosis of your compact flowmeter.
- Switch on system.
- Press the following keys for display of the status codes:

Key	Display	Description	
→			If "YES" set under Fct. 3.04 ENTRY CODE, key in the 9-keystroke CODE 1 now: → → → ↓ ↓ ↓ ↑ ↑ ↑
↑	Fct. 1.00	OPERATION	
→	Fct. 2.00	TEST	
→	Fct. 2.01	TEST Q	
↑	Fct. 2.02	HARDW. INFO	
→	→ MODUL ADC	-.-.-.-.-	1st window
↓	→ MODUL IO	-.-.-.-.-	2nd window
↓	→ MODUL DISP.	-.-.-.-.-	3rd window
PLEASE NOTE DOWN ALL 6 STATUS CODES !			
↓ (2x) 3x ↓	Fct. 2.02 -.-.-.-.-	HARDW. INFO -.-.-.-.- / -.-	Terminate hardware information Measuring mode

If you need to return your flowmeter to Krohne, please refer to last but one page of these Instructions !

7.4 Faults and symptoms during start-up and process flow measurement

- Most faults and symptoms occurring with the flowmeters can be eliminated with the aid of the following tables.
- For greater clarity, faults and symptoms in the tables are divided into 2 parts and various groups.
- Part 1** Signal converter **IFC 090 B** (B = basic version), **without** display **and without** HHT or CONFIG user program (see Sect. 6.2)

Groups: **LED** LED display (status messages)
 I Current output
 P Pulse output
 LED / I / P LED display, current output and pulse output
- Part 2** Signal converter **IFC 090 D** (D = display version) and Signal converter **IFC 090 B** (B = basic version), **without** display **but with** CONFIG user program (see Sect. 6.2)

Groups: **D** Display
 I Current output
 P Pulse output
 S Status indication output
 C Control input
 D / I / P / S LED display, current output, pulse output, status output and display

Before contacting Krohne Service, please read through the following tables. THANK YOU !

Part 1			
Converter IFC 090 B (B = basic version), without display and without HHT or CONFIG operator program			
Group LED	Fault / Symptom	Cause	Remedial action
LED 1	LED flashes red/green	Overranging of A/D converter, current or pulse output	Reduce flowrate; if unsuccessful, test as described in Sect. 7.5.
		Measuring tube drained, A/D converter overranged.	Fill measuring tube.
LED 2	LED flashes red	Fatal Error, hardware and/or software error	Replace signal converter (see Sect. 8.7) or contact Krohne Service.
LED 3	cyclic flashing of red LED, approx 1 second	Hardware fault, Watchdog activated.	Replace signal converter (see Sect. 8.7) or contact Krohne Service.
LED 4	LED shows red continuously	Hardware fault	Replace signal converter (see Sect. 8.7) or contact Krohne Service.
Group I	Fault / Symptom	Cause	Remedial action
I 1	Receiver instrument indicates "0".	Connection/polarity incorrect.	Connect properly as described in Sect. 2.3 + 2.7
		Receiver instrument defective.	Check connecting cables and receiver instrument, and replace if necessary.
		Short between current output and pulse output	Check connections and cables, see Sect. 2.3 + 2.7, voltage between I+ and I- approx. 15 V. Switch off device, eliminate short-circuit, switch device on.
		Current output defective	Replace signal converter (see Sect. 8.7) or contact Krohne Service.
I 2	22 mA present at current output (fault current)	Current output I overranged	Check device parameters and change if necessary, see Sect. 6.2, or contact Krohne Service

Part 1 (cont'd)	Converter IFC 090 B (B = basic version), without display and without HHT or CONFIG operator program		
Group I	Fault / Symptom	Cause	Remedial action
I 3	22 mA present at current output (fault current) and red LED shows.	Fatal Error	Replace signal converter (see Sect. 8.7) or contact Krohne Service
I 4	Unsteady display	Electrical conductivity of product too low	Increase time constant (see Sect. 6.2) or contact Krohne Service
I 5	Receiver instruments indicate "constant value"	Control input C set to "hold outputs"	Change setting (see Sect. 6.2) or contact Krohne Service
I 6	"Skipping" elec. current values	Current output set to "automatic range change"	Change hysteresis or range of tripping points, see Sect. 6.2 or contact Krohne Service
		Control input C set to "external range change"	Switch off or check level see Sect. 6.2 or contact Krohne Service
I 7	F/R flow measurement: different displays even though same volume flow rate in both directions	Different ranges set for "forward and reverse flow"	Change setting, see Sect. 6.2 or contact Krohne Service
I 8	Receiver instruments indicate "min. values"	Control input C set to "set outputs to zero"	Change setting, see Sect. 6.2 or contact Krohne Service
Group P	Fault / Symptom	Cause	Remedial action
P 1	Connected totalizer not counting any pulses	Connection/polarity incorrect	Connect properly as described in Sect. 2.4 + 2.7.
		Totalizer or external voltage source defective	Check connection cables, totalizer and external voltage source, and replace if necessary.
		Current output is external voltage source; short-circuit, or current/pulse output defective.	Check connection and cables (see Sect. 2.4 + 2.7), voltage between I+ and I.L approx. 15 V. Switch off device. Eliminate short-circuit and switch device on again. If no function then current or pulse output defective. Replace signal converter (see Sect. 8.7) or contact Krohne Service.
		Control input C is set to "hold outputs"	Change setting, see Sect. 6.2 or contact Krohne Service
		Pulse output inactive, see Fct. 1.06.	Switch on, see Sect. 6.2, or
		Fatal Error, red LED shows.	Replace signal converter (see Sect. 8.7) or contact Krohne Service.
		Output B1 set to status output or control input	Change setting, see Sect. 6.2 or contact Krohne Service
		Control input C is set to "set outputs to zero" and currently active	Change setting, see Sect. 6.2 or contact Krohne Service
P 2	Unsteady pulse rate	Electrical conductivity of product too low.	Increase time constant, see Sect. 6.2 or contact Krohne Service.
Group LED / I / P	Fault / Symptom	Cause	Remedial action
LED / I / P 1	Red LED flashes, current output indicates fault current and pulse output "0".	Fatal Error, hardware fault and/or software error	Replace signal converter (see Sect. 8.7) or contact Krohne Service.

Part 2		Signal converter IFC 090 D (D = display version) and Signal converter IFC 090 B (B = basic version), without display but with HHT or CONFIG operator program (see Sect. 6.2)	
Group D	Display shows . . .	Caus	Remedial action
D 1	LINE INT.	Power failure. <u>Note:</u> no counting during power failure.	Delete error message in RESET/QUIT. menu. Reset totalizer(s) if need be.
D 2	CUR.OUTP. I	Current output overranged.	Check instrument parameters and correct if necessary. Error message deleted automatically after cause has been eliminated.
D 3	PULS.OUTP. P	Pulse output overranged. <u>Note:</u> totalizer deviation possible	Check instrument parameters, correct if necessary, and reset totalizer(s). Error message deleted automatically after cause has been eliminated.
D 4	ADC	Analog/digital converter overranged.	Error message deleted automatically after cause has been eliminated.
D 5	FATAL. ERROR	Fatal Error, all outputs set to "min." values.	Replace signal converter (see Sect. 8.7) or contact Krohne Service, having first noted down hardware information and error status, see Fct. 2.02.
D 6	TOTALIZER	Counts lost (overflow, data error)	Delete error message in RESET/QUIT. menu.
D 7	„STARTUP“ cyclic flashing	Hardware fault, Watchdog activated.	Replace signal converter (see Sect. 8.7) or contact Krohne Service.
D 8	BUSY	Displays for flow, totalizers and errors disabled.	Change setting in Fct. 1.04.
D 9	Unsteady display	Low electrical conductivity, high solids content, pulsating flow.	Increase time constant in Fct. 1.02.
D 10	No display	Power OFF.	Switch on power
		Check power (fuse(s) F1 (F1 + F2 with DC).	Replace if defective (see Sect. 8.1).

Part 2	Signal converter IFC 090 D (D = display version) and Signal converter IFC 090 B (B = basic version), without display but with HHT or CONFIG operator program (see Sect. 6.2)		
Group I	Fault / Symptom	Cause	Remedial action
I 1	Receiver instrument indicates "0".	Incorrect connection/polarity	Connect properly see Sect. 2.3 + 2.7.
		Receiver instrument or current output defective.	Check output (see Sect. 7.2) with new milliammeter: <u>Test ok</u> , check connection cables and receiver instrument, replace if necessary. <u>Test faulty</u> , current output defective. Replace signal converter (see Sect. 8.7) or contact Krohne Service
		Current output disabled, see Fct. 1.05	Activate under Fct. 1.05.
		Short-circuit between current output and pulse output.	Check connection and cables, see Sect. 2.3 + 2.7. Voltage between I+ and I.L approx. 15 V. Switch off device, eliminate short-circuit, and switch device on again.
I 2	Unsteady display	Low electrical conductivity, high solids content, pulsating flow.	Increase time constant, see Fct. 1.02, or contact Krohne Service.

Part 2 (cont'd)	Signal converter IFC 090 D (D = display version) and Signal converter IFC 090 B (B = basic version), without display but with HHT or CONFIG operator program (see Sect. 6.2)		
Group P	Fault / Symptom	Cause	Remedial action
P 1	Totalizer connected but does not count any pulses	Incorrect connection/polarity	Connect properly, see Sect. 2.4 + 2.7.
		Totalizer or external voltage source defective.	Check output (see Sect. 7.2) with new totalizer: <u>Test ok</u> , check connection cables and previous totalizers and external voltage source, and replace if necessary. <u>Test faulty</u> , pulse output defective, replace signal converter (see Sect. 8.7) or contact Krohne Service.
		Current output is external voltage source, short circuit or current / pulse output defective	Check connection and cables, see Sect. 2.3, 2.4 + 2.7. Voltage between I+ and I- approx. 15 V. Switch off device, eliminate short circuit, switch device on again. If no function, then current or pulse output defective. Replace signal converter (see Sect. 8.7) or contact Krohne Service.
		Pulse output is deactivated, see Fct. 1.06.	Switch on under Fct. 1.06.
P 2	Unsteady pulse rate	Electrical conductivity of product too low, time constant too low or switched off for pulse output.	Increase time constant under Fct. 1.02, or switch on.
P 3	Pulse rate too high or too low.	Incorrect setting for pulse output.	Change setting under Fct. 1.06.

Part 2 (cont'd)	Signal converter IFC 090 D (D = display version) and Signal converter IFC 090 B (B = basic version), without display but with HHT or CONFIG operator program (see Sect. 6.2)		
Group S	Fault / Symptom	Cause	Remedial action
S 1	No function	Incorrect connection/polarity of status display	Connect properly, see Sect. 2.5 + 2.7.
		Status display or output defective or external voltage source not supplying voltage.	Set status output under Fct. 1.07 to "F/R INDIC." (flow direction) and check (see Sect. 7.2) with new status display: <u>Test ok</u> , check previous status display and external voltage source, and replace if necessary. <u>Test faulty</u> , status output defective, replace signal converter (see Sect. 8.7) or contact Krohne Service.
		Output terminal B1 or B2 not set to "status output"	Change setting under Fct. 3.07
Group D/I/P/S	Fault / Symptom	Caus	Remedial action
D / I / P / S 1	Unsteady display and outputs	Electrical conductivity of product too low, time constant too low.	Increase time constant under Fct. 1.02.
D / I / P / S 2	No display and no function of outputs	Power OFF	Switch power on.
		Check power fuse(s) F1 (F1 + F2 for DC).	Replace if defective, see Sect. 8.1.
Group C	Fault / Symptom	Cause	Remedial action
C 1	No function	Connection is incorrect	Connect properly, see Sect. 2.6 + 2.7
		Control input C or external voltage source defective	Check connection, cables and external voltage source, see Sect. 2.6 + 2.7
		Output terminal B1 or B2 not set to "control input"	Change setting under Fct. 3.07.

7.5 Test of primary head

Always switch off power source before opening the housing !

Required measuring instruments and tools

- Special wrench to unscrew the covers, a crosstip screwdriver
- Ohmmeter with at least 6 V range
or AC voltage/resistance measuring bridge.

Note: Accurate measurements in the area of the electrodes can only be obtained with an AC voltage/resistance bridge. Also, the measured resistance is very heavily dependent on the electrical conductivity of the liquid product.

Preparatory work

- **Switch off power source.**
- Unscrew covers from terminal and electronic compartments using the special wrench. If provided, remove the display unit. For this purpose, detach the two screws **R** and fold display unit to the side, see figure in Sect. 8.5.
- Pull off the blue 9-pin plug from the amplifier PCB, see figure in Sect. 8.9, field power supply (Pin 7+8) and signal cables (Pin 1, 2, 3, 4 + 5)
- Completely fill the measuring tube of the flowmeter with the process liquid.

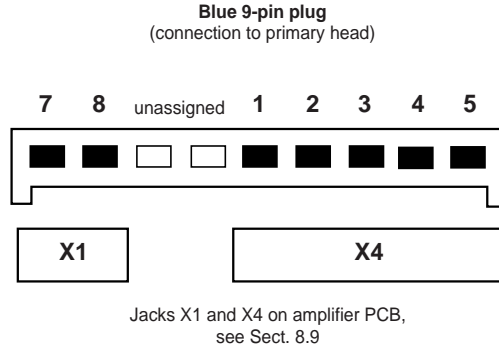

Action		Typical result	Incorrect result = flowmeter defective, return to factory for repair, refer to last but one page !
1	Measure resistance between wires 7 and 8 .	30 - 150 Ω	if lower: interwinding fault
			if higher: wire break
2	Measure resistance between U-clamp terminal in terminal compartment (PE protective conductor or FE functional ground) and wires 7 and 8	> 10 MΩ	if lower: interwinding fault to PE or FE.
3	Measure resistance between wires 1 and 3 and between 1 and 4 (same measuring lead always on wire 1 !)	1 kΩ - 1 MΩ (see "Note" above). Both values should be approx. equal.	if lower: drain measuring tube and repeat measurement; if still too low, short-circuit in electrode wires.
			if higher: break in electrode wires or electrodes contaminated.
			Values not equal: break in electrode wires or electrodes contaminated.

GS 8A operating elements and accessories

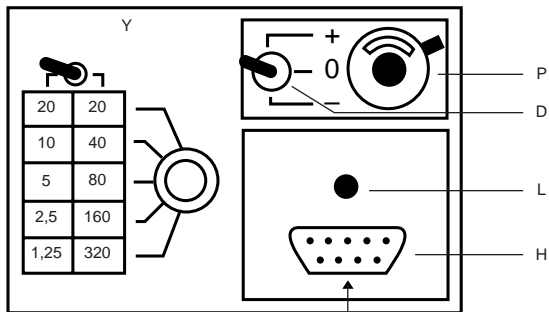

- B** Plug for field power supply, 2-pin
- C5** Plug for signal cable, 5-pin
- D** Switch, flow direction
- H** Socket for **H2** plug on cable **Z**
- H2** Plug of cable **Z**
- L** Power supply ON
- P** Potentiometer "zero"
- X1** Socket for plug **B** on amplifier PCB
- X4** Socket for plug **C5** on amplifier PCB
- Y** Switch, measuring ranges
- Z** Cable between GS 8A and signal converter

Electrical connection

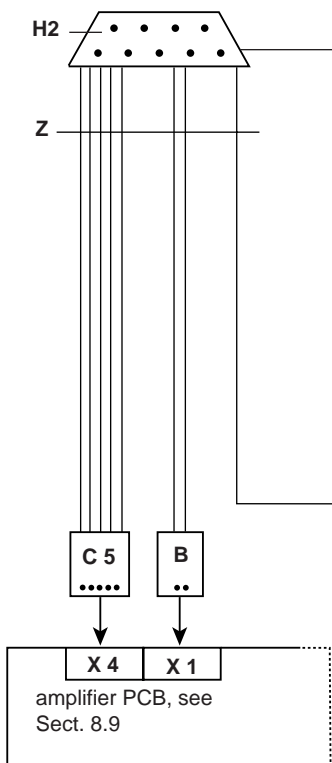

Using GS 8 simulator
 Additional adapter is required between GS 8 and IFC 090 signal converter.
 Order No. 2.10764.00.

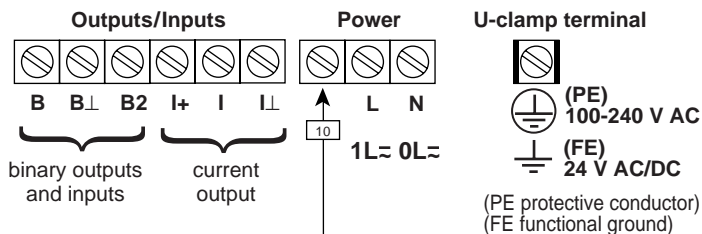

Connection of millimeter and electronic frequency counter see Sect. 2.6.

(A) Millimeter, accuracy class 0.1, $R_i < 500 \Omega$, range 4-20 mA

(Σ) Electronic frequency counter, input resistance approx. 1 k Ω , range 0-1 kHz, time base min. 1 second, see connection diagrams in Sect. 2.6.

- a) **Switch off power source before opening the housing !**
- b) Unscrew the cover from electronic section using the special wrench.
- c) Remove screws **R** and fold display unit to side, see illustration in Sect. 8.5.
- d) Pull off blue 9-pin plug (X1/X4) from the amplifier PCB, see Sect. 8.9: socket **X1** field power supply, and socket **X4** signal cables.
- e) Connect plug **B** to socket **X1** (2-pin) and plug **C** (5-pin) to socket **X4** (5-pin).

Warning: Instrument must be properly grounded to avoid personnel shock hazard.

Check of setpoint display

- 1) Switch on power source, allow at least 15 minutes' warm-up time.
- 2) Set switch **D** (front panel of GS 8A) to "0" position.
- 3) Adjust zero to 0 or 4 mA with the 10-turn potentiometer **P** (front panel of GS 8A), depending on setting in Fct. 1.05, deviation $<\pm 10 \mu\text{A}$.
- 4) Calculate position of switch **Y** and displayed setpoints "**I**" and "**f**":

$$4.1) X = \frac{Q_{100\%} \times K}{GK \times DN^2}$$

$Q_{100\%}$ full-scale range (100%) in volumetric unit **V** per unit time **t**
GK primary constant, see instrument nameplate
DN meter size DN in mm, not inches, see instrument nameplate
t time in seconds (**Sec**), minutes (**min**) or hours (**hr**)
V volumetric unit
K constant, according to following table

V \ t	Sec	min	hr
Liter	25 464	424.4	7.074
m ³	25 464 800	424 413	7 074
US gallons	96 396	1 607	26.78

Note:

Sticker on the GS 8 primary head simulator still gives values for "inch" flowmeter. **Do not use any more !**

- 4.2) Determine position of switch Y: Use table (front panel GS 8A) to determine value **Y** which comes closest to factor **X** and meets condition $Y \leq X$.
- 4.3) Calculate setpoint reading "I" for current output: $I = I_{0\%} + \frac{Y}{X} (I_{100\%} - I_{0\%})$ in mA
 $I_{0\%}$ current (0/4mA) at 0% flowrate
 $I_{100\%}$ current (20mA) at 100% flowrate
- 4.4) Calculate setpoint reading "f" for pulse output: $f = \frac{Y}{X} \times P_{100\%}$ in Hz
 $P_{100\%}$ pulses per second (Hz) at 100% flowrate
- 5) Set switch **D** (front panel GS 8A) to position "+" or "-" (forward/reverse flow).
- 6) Set switch **Y** (front panel GS 8A) to the value determined by the method described above.
- 7) Check setpoint readings **I** and **f**, see points 4.3 and 4.4 above.
- 8) Deviation $< 1.5\%$ of setpoint. If greater, replace signal converter, see Sect. 8.7.
- 9) Test of linearity: set lower **Y** values, readings will drop in proportion to the calculated **Y** values.
- 10) **Switch off power source** after completing the test.
- 11) Disconnect the GS 8A.
- 12) Reassemble in reverse order, see points e) – b) under "electrical connection", see illustration in Sect. 8.5.
- 13) The system is ready for operation after the power source has been switched on.

Example: see overleaf

Example

Full-scale range	$Q_{100\%}$	= 200 m ³ /hr (Fct. 1.01)
Meter size	DN	= 80 mm = 3" (Fct. 3.02)
Current at $Q_{0\%}$	$I_{0\%}$	= 4 mA
	$I_{100\%}$	= 20 mA
		} (Fct. 1.05)
Pulses at $Q_{100\%}$	$P_{100\%}$	= 280 pulses/hr (Fct. 1.06)
Primary head constant	GK	= 3.571 (see nameplate)
Constant (V in m3)		
(t in hr)	K	= 7074 (see Table)
(DN in mm)		

Calculation of "X" and position of "Y"

$$X = \frac{Q_{100\%} \times K}{GK \times DN^2} = \frac{200 \times 7074}{3.571 \times 80 \times 80} = 61.905$$

Y = 80, position of switch Y, see front panel GS 8A
(comes closest to X value and is smaller than X).

Calculation of setpoint readings **I** and **f**

$$I = I_{0\%} + \frac{Y}{X} (I_{100\%} - I_{0\%}) = 4 \text{ mA} + \frac{40}{61.905} (20\text{mA} - 4\text{mA}) = 14.3 \text{ mA}$$

Deviations are permissible between 14.1 and 14.6 mA (equivalent to $\pm 1.5 \%$).

$$f = \frac{Y}{X} \times P_{100\%} = \frac{40}{61.905} \times \text{pulses / hr} = 129.2 \text{ pulses/hr}$$

Deviations are permissible between 127.3 and 131.1 pulses/hr (equivalent to $\pm 1.5 \%$).

**If you need to return your flowmeter to Krohne,
please refer to last but one page of these Instructions !**

8. Service

8.1 Replacement of power fuses

A) Fuse F1 in AC Versions 1 and 2

Switch off power source before opening the housing !

- 1) Unscrew cover of electronics compartment using the special wrench.
- 2) If provided, remove the display unit.
For this purpose, detach the two screws **R** and fold display unit to side.
- 3) Take out old and insert new power fuse **F1**.
Refer to the table in Sect. 8.5 for fuse rating and order number.
- 4) Reassemble in reverse order, items 2) - 1) above.

B) Fuses F1 and F2 in the AC/DC Version

Switch off power source before opening the housing !

- 1) Unscrew cover from the terminal compartment using the special wrench.
Pull off the two plugs for power (3-pin) and outputs/inputs (5-pin).
- 2) Unscrew cover from the electronics compartment using the special wrench.
- 3) If provided, remove display unit.
For this purpose, detach the two screws **R** and fold display unit to the side.
- 4) Carefully pull off the blue 9-pin plug **X1/X4**
(forming the connection to the primary head).
- 5) Detach the 2 recessed head screws **Q** and carefully remove the electronic unit.
- 6) Replace power fuses **F1** and **F2** on the power supply PCB,
refer to Sect. 8.9 for illustration of the PCB. Refer to the table in Sect. 8.5 for fuse ratings and order numbers.
- 7) Reassemble in reverse order, points 5) - 1) above.

8.2 Changeover of operating voltage on AC Versions 1 and 2

Switch off power source before opening the housing !

- 1) Unscrew the cover from the terminal compartment using the special wrench.
Pull off the two plugs for power (3-pin) and outputs/inputs (5-pin).
- 2) Unscrew the cover from the electronics compartment using the special wrench.
- 3) If provided, remove display unit.
For this purpose, detach the two screws **R** and fold display unit to the side.
- 4) Carefully pull off the blue 9-pin plug **X1/X4**
(forming the connection to the primary head).
- 5) Detach the 2 recessed head screws **Q** and carefully remove the electronic unit.
- 6) Transpose the voltage selector **SW** on the power supply PCB (see diagram in Sect. 8.9)
to obtain the required voltage according to the table in Sect. 8.5.
- 7) Change power fuse **F1**, refer to table in Sect. 8.5 for fuse rating.
- 8) Reassemble in reverse order, points 5) - 1) above.

8.3 Turning the display PCB

Switch off power source before opening the housing !

- 1) Unscrew cover from electronic compartment using the special wrench.
- 2) Detach the two screws **R** and carefully turn the display unit $\pm 90^\circ$ or 180° .
- 3) If display turned $\pm 90^\circ$, reposition the screws **R** on the display board.
- 4) Reassemble in reverse order, points 2) - 1) above.

Warning: Instrument must be properly grounded to avoid personnel shock hazard.

Switch off power source before opening the housing !

- 1) Unscrew the cover from the electronic compartment using the special wrench.
- 2) Insert plug for display unit into socket **X6** on the amplifier PCB, see diagrams in Sect. 8.5 and 8.9.
- 3) Secure the plug by means of the supplied metal clip to prevent it from dropping out.
- 4) Tighten down the display PCB with screws **R**.
- 5) Switch on power.
- 6) Refer to Sect. 4 and 5 for operator control and display of measured values.
- 7) Grease the thread and gasket of the new housing cover, with recess for the display, and tighten down using the special wrench.



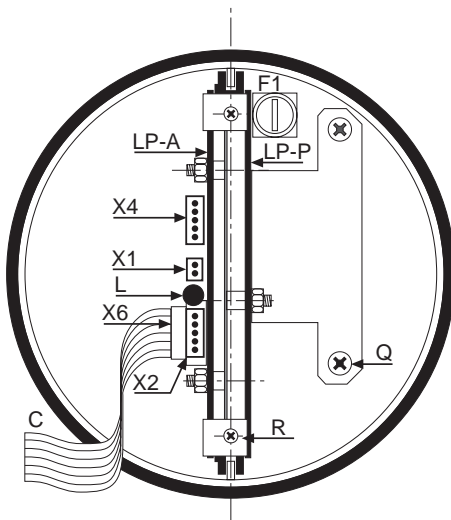





Power fuses and illustrations to Sect. 8.1 to 8.4 8.5

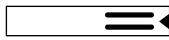

IMPORTANT !
 The screw threads and gaskets of both housing covers should be well greased at all times, always check for signs of damage and never allow dirt to accumulate. Replace defective gaskets immediately.

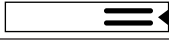
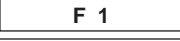
- C** Ribbon cable, display unit
- L** Status LED
- LP-A** Amplifier board, see Sect. 8.9
- LP-P** Power supply board, see Sect. 8.9
- Q** Fastening screws, electronic unit
- R** Fastening screws, display unit
- X1** 2-pin connector, field power
- X2** 5-pin connector, IMoCom bus
- X4** 5-pin connector, electrode signals
- X6** 10-pin connector, display unit

Warning: Instrument must be properly grounded to avoid personnel shock hazard.

Power supply	Voltage	Fuses F1 (and F2)		Location and position of voltage selector SW
		Rating	Order No.	
1. AC Version	230/240 V AC	125 mA T	5.06627	 
	115/117 V AC	200 mA T	5.05678	 
2. AC Version	200 V AC	125 mA T	5.06627	 
	100 V AC	200 mA T	5.05678	 
AC/DC Version	24 V AC/DC	F1 + F2 1.25 A T	5.09080	 

8.6 Turning the converter housing of the compact flowmeters

To facilitate access to connecting, indicating and operating elements for flowmeters installed in locations that are hard to get at, the signal converter housing can be turned through $\pm 90^\circ$.
Not allowed for flowmeters of **hazardous-duty (Ex) design!**

Available versions of flowmeters with IFC 090 K signal converter

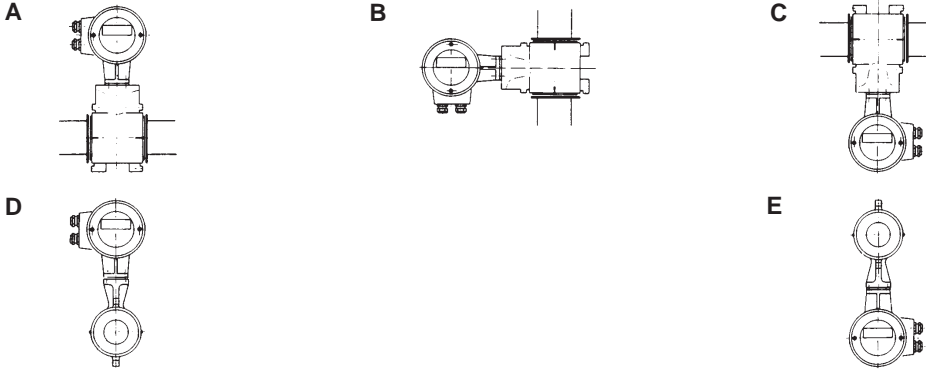

Turning the converter housing

Any faults resulting from failure to follow these instructions scrupulously shall not be covered by our warranty !

Switch off power source before opening the housing !

- 1) Clamp the flowmeter firmly by the primary head housing.
- 2) Secure converter housing against slipping and tilting.
- 3) Remove the 2 hexagon socket screws connecting the two housings, and push out the 2 plugs.
- 4) Carefully turn the converter housing clockwise or anti-clockwise a maximum of 90° , but do not lift the housing. If the gasket should stick, do not attempt to lever it off.
- 5) To conform to the requirements of protection category IP 67, equivalent to NEMA 6, keep connecting faces clean and tighten the 2 hexagon socket screws uniformly. Replace the plugs in the two free holes.

8.7 IFC 090 Replacement of converter electronic unit

A special electronic unit is available for hazardous-duty flowmeters, see separate "Ex" installation instructions.

Switch off power source before opening the housing !

- 1) Unscrew the cover from the terminal compartment using the special wrench. Pull off the two plugs for power (3-pin) and outputs/inputs (5-pin).
- 2) Unscrew the cover from the electronic compartment using the special wrench.
- 3) If provided, remove display unit. For this purpose, detach the two screws **R** and fold display unit to the side (illustration, see Sect. 8.8).
- 4) Carefully pull off the blue 9-pin plug **X1/X4** (forming the connection to the primary head).
- 5) Detach the 2 recessed head screws **Q** and carefully remove the electronic unit.
- 6) Carefully transfer DATAPROM **IC 18** on the amplifier PCB (illustration, see Sect. 8.9) from the "old" to the "new" electronic unit. When inserting, ensure direction of the IC is correct, see Sect. 8.9 "Illustration of circuit boards".
- 7) On the new electronic unit, check supply power and fuse **F1**, and if necessary change over or renew as described in Sect. 8.2, points 6) and 7).
- 8) Reassemble in reverse order, points 5) - 1) above.

Replacement not allowed on flowmeters of hazardous-duty design !

Please consult factory.

Before dismantling the old electronic unit, please note down all converter settings and use these for the new unit after it has been installed.

Switch off power source before opening the housing !

- 1) Unscrew the cover from the terminal compartment using the special wrench and disconnect all cables from the terminals; **note down terminal assignment** beforehand.
- 2) Unscrew the cover from the electronic compartment using the special wrench.
- 3) Detach the two screws **R** and fold display unit to the side.
- 4) Carefully pull off the two blue plugs: **2-pin** field power cable and **5-pin** signal cable (forming connection to primary head).
- 5) Unscrew the 2 recessed head screws **Q** (size 2 screwdriver, blade length 200 mm / 8") and pull out "old" electronic unit.
- 6) On the new electronic unit check supply power and fuse **F1** and change over/replace if necessary, refer to Sect. 8.2, points 6) and 7).
- 7) Pull off the two plugs for power (3-pin) and outputs/inputs (6-pin) and carefully insert the new electronic unit into the housing.
- 8) Detach the two screws **R** and fold display unit to the side.
- 9) Secure the electronic unit with the two screws **Q**.
- 10) On the amplifier PCB (see illustration in Sect. 8.9), insert the **2-pin** plug of the field power cable into plug connector **X1** and the **5-pin** plug of the signal cable into plug connector **X4**. Do not kink or twist the cables.
- 11) Secure the display unit with screws **R**.
- 12) In the terminal compartment, press the supplied cover for the terminals into the housing and connect the cables to the plugs (3-pin for supply power, 6-pin for inputs/outputs). Ensure terminal assignment is correct, see Sect. 2. Subsequently insert the plugs into connectors **X3** (supply power) and **X5** (outputs/inputs).
- 13) Replace the cover of the terminal compartment and secure using the special wrench.
- 14) Switch on the power. Check all settings and change if necessary. For setting and operator control, refer to Sect. 4 and 5. Set the GK value (or 1/2 × GKL value) for the IFC 090, see instrument nameplate.
- 15) Subsequently be sure to check the zero, as described in Sect. 7.1.
- 16) Replace cover on the electronic compartment and secure using the special wrench.

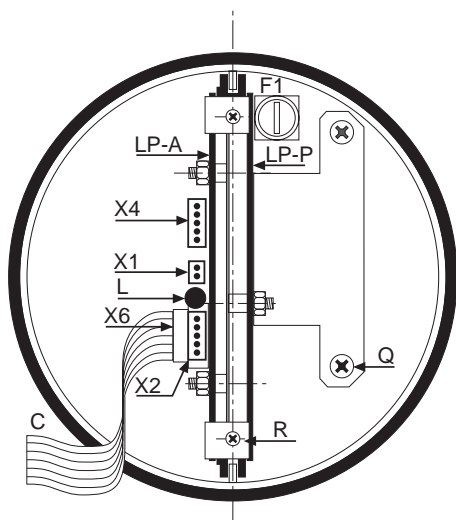
**IMPORTANT !**

The screw threads and gaskets of both housing covers should be well greased at all times, always check for signs of damage and never allow dirt to accumulate. Replace defective gaskets immediately.

- | | |
|-------------|------------------------------------|
| C | Ribbon cable, display unit |
| L | Status LED |
| LP-A | Amplifier board, see Sect. 8.9 |
| LP-P | Power supply board, see Sect. 8.9 |
| Q | Fastening screws, electronic unit |
| R | Fastening screws, display unit |
| X1 | 2-pin connector, field power |
| X2 | 5-pin connector, IMoCom bus |
| X4 | 5-pin connector, electrode signals |
| X6 | 10-pin connector, display unit |

8.9 Illustrations of the PCBs

A) Amplifier PCB, standard version

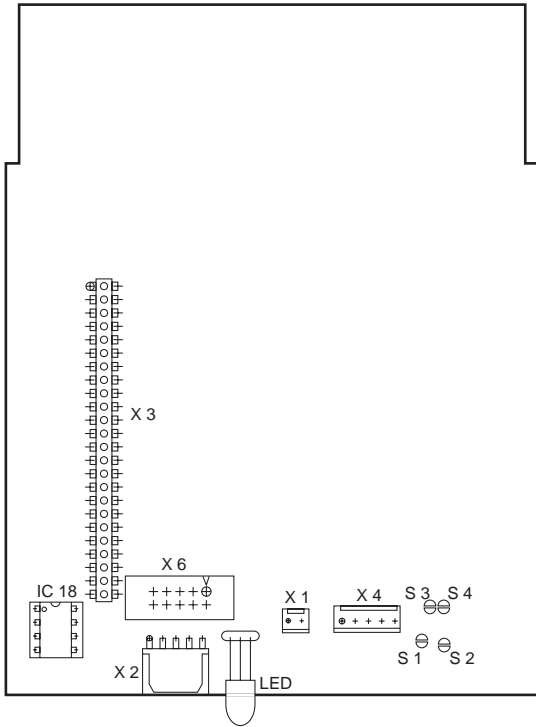

Solder points S1 and S3



IC 18	DATAPROM (sensor IC)
S1, S3	for empty-tube cut-off, see Sect. 6.3
S2, S4	not used
X1	2-pin plug connector, Pin 7 and 8, see Sect. 7.5 and 7.7
X2	IMoCom bus, plug connector for connec- tion of external add-on equipment, see Sect. 6.2
X3	24-pin socket connector
X4	5-pin plug connector, Pins 1-5, signal cable, see Sect. 7.5 and 7.7
X6	10-pin plug connector for dispay unit, see Sect. 8.4

B) Power supply PCB, AC Versions 1 and 2

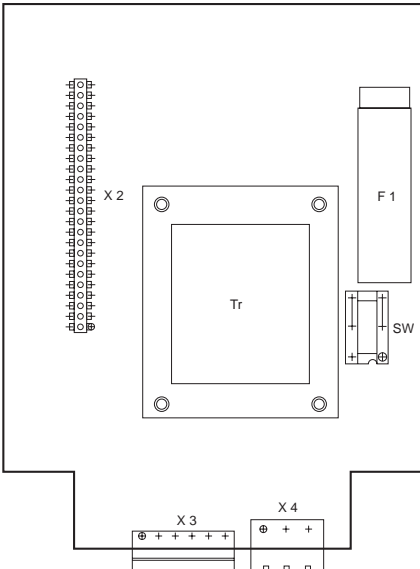

F1	Power fuse, ratings see Sect. 8.5 or 9
SW	Voltage selector, to change the voltage, see Sect. 8.2
Tr	Transformer

C) Power supply PCB, DC Version

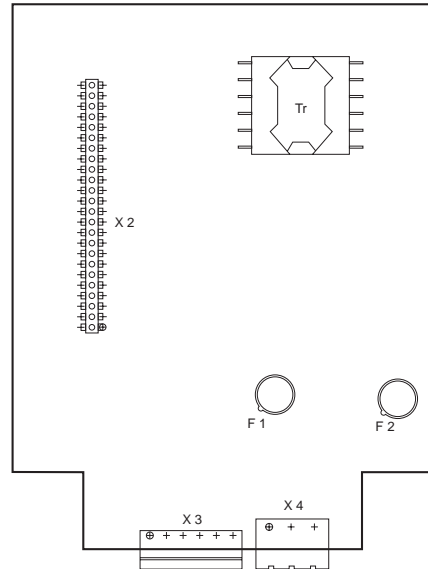

F1, F2	Power fuses, ratings see Sect. 8.5 or 9
Tr	Transformer

IFC 090 electronic unit and power fuses

Power supply unit	Supply power	Order No.				IFC 090 D-Ex with Display	
		IFC 090 D with Display	IFC 090 B without Display	Power fuses (not for "Ex" versions!)			
1. AC Version	230/240 V AC	2.10662.10	2.10662.00	F1 1)	125 mA T	5.06627	2.10662.00
	115/120 V AC	2.10662.12	2.10662.02	F1 1)	200 mA T	5.05678	2.10662.02
2. AC Version	200 V AC	2.10662.14	2.10662.04	F1 1)	125 mA T	5.06627	2.10662.04
	100 V AC	2.10662.13	2.10662.03	F1 1)	200 mA T	5.05678	2.10662.03
AC/DC Version	24 V AC/DC	2.10663.10	2.10663.00	F1 + F2 2)	1.25 A T	5.09080	2.10663.00

1) 5 x 20 G fuse, switching capacity 1500 A

2) TR 5, switching capacity 35 A

IFC 090 Spares and accessories	Order No.
Plug for supply power: all AC Versions (100-240 V AC) 24 V AC/DC Versions for outputs/inputs	3.31122.02
	3.31122.03
	3.31122.01
Display unit , retrofit kit for Basic version IFC 090 K / B, incl. cover with cut-out, clip and connecting cable	1.30928.33
RS 232 adapter incl. CONFIG user software to operate the signal converter via MS-DOS PC or Laptop	German 2.10531.00
	English 2.10531.01
HHT hand-held terminal to operate the signal converter	2.10827.00
Special wrench for opening the housing cover	3.31038.10
Bar magnet to operate the display converter without opening the housing	2.07053.00
Signal converter simulator GS 8A	2.07068.01
Adapter for adjustment of older GS 8 simulators to the IFC 090 converter	2.10764.00
O-ring gaskets for housing cover	3.30870.02
Antiseize/lubricant for screw thread and O-ring gaskets on housing cover	

Part D Technical Data, Measuring Principle and Block Diagram

10 IFC 110 F technical data

10.1 Full-scale range $Q_{100\%}$

Full-scale ranges $Q_{100\%}$

Flow rate $Q = 100\%$ 6 liter/h to 33 900 m³/h (0.03 - 156 000 US Gal/min), adjustable as required, equivalent flow velocity 0.3 - 12 m/s (1 - 40 ft/s)

Unit m³/hr, Liter/Sec, US gallons/min. or user-defined unit, e.g. Liter/day or US MGal/day

Flow tables

$v =$ flow velocity in m/s

Meter size		Full-scale range $Q_{100\%}$ in m ³ /h		
DN		$v = 0.3$ m/s	$v = 1$ m/s	$v = 12$ m/s
mm	inch	(minimum)		(maximum)
2.5	1/10	0.0053	0.0177	0.2121
4	1/8	0.0136	0.4520	0.5429
6	1/4	0.0306	0.1018	1.222
10	3/8	0.0849	0.2827	3.392
15	1/2	0.1909	0.6362	7.634
20	3/4	0.3393	1.131	13.57
25	1	0.5302	1.767	21.20
32	-	0.8686	2.895	34.74
40	1 1/2	1.358	4.524	54.28
50	2	2.121	7.069	84.82
65	-	3.584	11.95	143.3
80	3	5.429	18.10	217.1
100	4	8.483	28.27	339.2
125	-	13.26	44.18	530.1
150	6	19.09	63.62	763.4
200	8	33.93	113.1	1357
250	10	53.02	176.7	2120
300	12	76.35	254.5	3053
400	16	135.8	452.4	5428
500	20	212.1	706.9	8482
600	24	305.4	1018	12215
700	28	415.6	1385	16625
800	32	542.9	1810	21714
900	36	662.8	2290	26510
1000	40	848.2	2827	33929

$v =$ flow velocity in ft/s

Meter size		$Q_{100\%}$ in US Gal/min	
DN		$v = 1$ ft/s	$v = 40$ ft/s
mm	inch	(minimum)	(maximum)
2.5	1/10	0.0245	0.979
4	1/8	0.0383	1.530
6	1/4	0.1530	6.120
10	3/8	0.3735	14.93
15	1/2	0.8405	33.61
20	3/4	1.494	59.75
25	1	2.334	93.34
32	1 1/4	3.824	153.0
40	1 1/2	5.979	239.0
50	2	9.339	373.5
65	2 1/2	15.78	630.9
80	3	23.90	955.6
100	4	37.35	1493
125	5	58.38	2334
150	6	84.05	3361
200	8	149.43	5975
250	10	233.4	9334
300	12	336.2	13442
400	16	597.9	23899
500	20	933.9	37345
600	24	1345	53781
700	28	1919	76760
800	32	2507	100272
900	36	3173	126904
1000	40	3917	156672

10.2 IFC 090 F and ZD Dimensions and weights

IFC 090 F Signal converter Weight approx. 4.2 kg/9.3 lbs

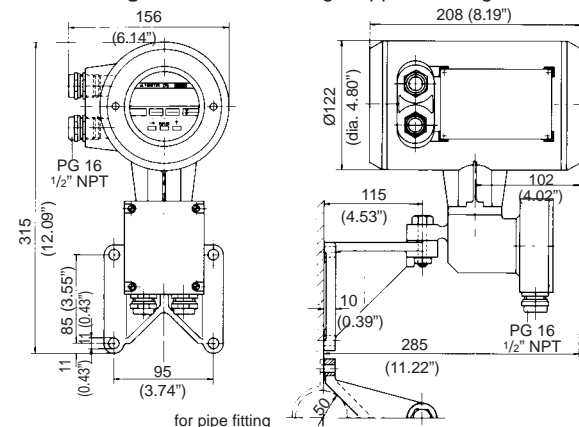

ZD Intermediate connection box Weight approx. 0.5 kg/1.1 lbs

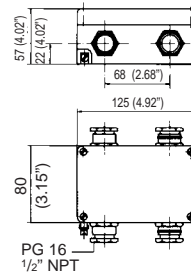

Display, digital values, pulse output

F maximum error in % of measured value (not typical values)

v Flow velocity in m/s and ft/s

Reference conditions similar to EN 29104

Product	water at 10 – 30°C/50 – 86°F
Electrical conductivity	> 300 µS/cm
Power supply (rated voltage)	$U_N (\pm 2\%)$
Ambient temperature	20 – 22°C/68 – 71.6°F
Warm-up time	60 min
Inlet/outlet runs	10 × DN/2 × DN (DN = meter size)
Primary head	properly grounded and centered

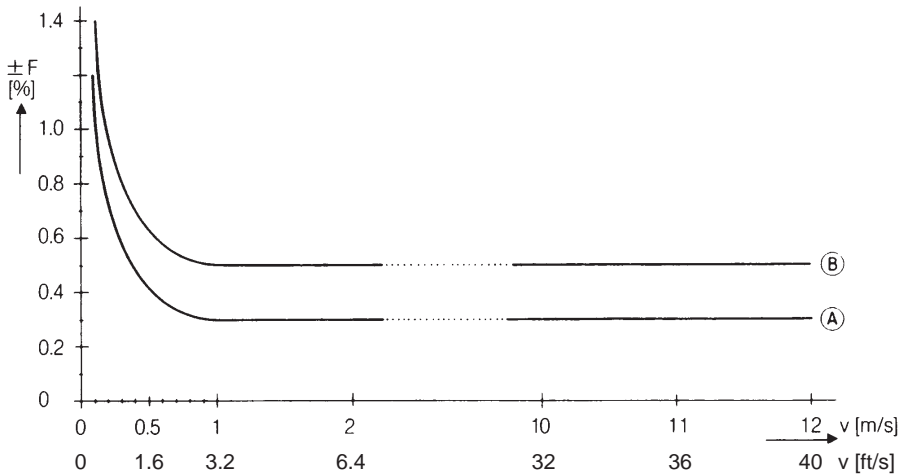

Type/Meter size		Maximum error in % of measured value (MV) ...		Curve
DN mm	inch	$v \geq 1 \text{ m/s} / \geq 3 \text{ ft/s}$	$v < 1 \text{ m/s} / < 3 \text{ ft/s}$	
DN 2.5 – 6(1)	$1/10'' - 1/4''(1)$	$\leq \pm 0.5\%$ of MV	$\leq \pm (0.4\%$ of MV + 1 mm/s) $\leq \pm (0.4\%$ of MV + 0.04 inch/s)	B
\geq DN 10	$\geq 3/8''$	$\leq \pm 0.3\%$ of MV	$\leq \pm (0.2\%$ of MV + 1 mm/s) $\leq \pm (0.2\%$ of MV + 0.04 inch/s)	

Current output same error limits as above, additionally $\pm 10 \mu\text{A}$

Reproducibility and repeatability 0.1% of MV, minimum 1 mm/s / 0.04 inch/s at constant flow

External influences typical values maximum values

Ambient temperature

Pulse output 0.003% of MV (2) 0.01 % of MV (2) } per 1 K / 1.8°F variation
 Current output 0.01 % of MV (2) 0.025% of MV (2) }

Power supply < 0.02 % of MV 0.05 % of MV (2) at 10% variation

Load < 0.01 % of MV 0.02 % of MV (2) at max. permissible load, see Sect. 10.4

(1) IFM 6080 K and IFS 6000 F (DN 2.5 – 4 and 1/10 – 1/6") additional error $\pm 0.3\%$ of MV

(2) All Krohne signal converters undergo burn-in tests, duration minimum 20 hours at varying ambient temperatures – 20 to + 60°C/– 4 to + 140°F. The tests are controlled by computers.

10.4 IFC 090 Signal converter

Versions IFC 090 K/B and F/B (standard) IFC 090 K/D and F/D (option) IFC 090 K/D-EEEx	K = contact Basic version, without local display and control elements Display version, with local display and control elements Hazardous-duty version with outputs in Increased Safety	F = separate, field housing						
Interface (option)	HART							
Add-on equipment (option)	CONFIG software and adapter for operator control via MS-DOS PC, connection to internal IMoCom interface (equipment bus)							
Current output								
Function	<ul style="list-style-type: none"> – all operating data settable – galvanically isolated from all output and input circuits – for active or passive mode (Ex version only active) 							
Current:	fixed ranges variable ranges	0 – 20 mA and 4 – 20 mA for Q = 0% $I_{0\%} = 0 - 16 \text{ mA}$ for Q = 100% $I_{100\%} = 4 - 20 \text{ mA}$ for Q > 100% $I > 20 \text{ up to } 22 \text{ mA maximum}$	} adjustable in 1mA } increments					
Active mode	max. 500 Ω load							
Passive mode	<table border="1" style="width: 100%; border-collapse: collapse;"> <tr> <td style="padding: 2px;">external voltage:</td> <td style="padding: 2px;">15 ... 20 V DC</td> <td style="padding: 2px;">20 ... 32 V DC</td> </tr> <tr> <td style="padding: 2px;">load: min. ... max.</td> <td style="padding: 2px;">0 ... 500 Ω</td> <td style="padding: 2px;">250 ... 750 Ω</td> </tr> </table>		external voltage:	15 ... 20 V DC	20 ... 32 V DC	load: min. ... max.	0 ... 500 Ω	250 ... 750 Ω
external voltage:	15 ... 20 V DC	20 ... 32 V DC						
load: min. ... max.	0 ... 500 Ω	250 ... 750 Ω						
Error identification	0 / 22 mA and variable							
Forward/reverse flow measurement	direction identified via status output							
Pulse output								
Function	<ul style="list-style-type: none"> – all operating data settable – galvanically isolated from current output and all input circuits – digital pulse division, interpulse period non-uniform, therefore if frequency and cycle meters connected allow for minimum counting interval: $\text{gate time, totalizer} \geq \frac{1000}{P_{100\%} [\text{Hz}]}$							
Activ mode	connection: electronic totalizers voltage: approx. 15 V DC, from current output load: $I_{\text{max}} < 23 \text{ mA}$, operation without current output $I_{\text{max}} < 3 \text{ mA}$, operation with current output							
Passive mode	connection: electronic or electromechanical totalizers voltage: external, $U_{\text{ext}} \leq 32 \text{ V DC} / \leq 24 \text{ V AC}$ load: $I_{\text{max}} \leq 150 \text{ mA}$							
Pulse width	automatic: pulse duty cycle 1:1, max. 1000 pulses/s = 1 kHz variable: $10 \text{ ms} - 1 \text{ s}$ $P_{100\%} [\text{pulses/s}] = f_{\text{max}} [\text{Hz}] = \frac{1}{2 \times \text{pulse width}}$							
Forward/reverse flow measurement	flow direction identified via status output							
Status output (passive)								
Function	settable as measuring range identification for BA mode, indicator for flow direction, errors or trip point							
Connection	voltage: external, $U_{\text{ext}} \leq 32 \text{ V DC} / \leq 24 \text{ V AC}$ load current: $I_{\text{max}} \leq 150 \text{ mA}$							

Control input (passive)			
Function	– settable for range change, totalizer reset, error reset, set outputs to min. values or hold actual output values – initiate function by “low” or “high” control signals		
Control signals	U_{max}: 24 V AC low: ≤ 1,4 V high: ≥ 3 V	32 V DC (any polarity) ≤ 2 V ≥ 4 V	
Output/input combinations		I = current output P = pulse output S = status output C = control input the following combinations can be set: 1) I P S 2) I P C 3) I C S 4) I S C 5) I S1 S2 6) I C1 C2	
Time constant		0.2 – 99.9 s, adjustable in increments of 0.1 second	
Low-flow cutoff		Cutoff “on” value: 1 – 19% Cutoff “off” value: 2 – 20%	
		} of Q _{100%} , adjustable in 1% increments	
Local display (D version)		3-field LCD	
Display function		actual flowrate, forward, reverse and sum totalizers (7-digit), or 25-character bar graph with percentage indication and status messages	
Units:	Actual flowrate	m ³ /h, liter/s., US gallons/min or user-defined unit, e. g. liters/day	
Totalizer		m ³ , liters, US gallons or user-defined unit, e. g. hecto-liters or US gallons/day (adjustable count duration up to overflow)	
Language of plain texts		English, German, French, others on request	
Display:	Top field	8-character, 7-segment numeral and sign display, and symbols for key acknowledgement	
	Middle field	10-character, 14-segment text display	
	Bottom field	4 markers to identify display in measuring mode	
Operator control		– 3 keys → ↵ ↑ or – 3 magnetic sensors and the supplied bar magnet without opening the housing	
Power supply		1. AC Version	2. AC Version
		Standard	Option
		AC/DC Version	
		Option	
1. Rated voltage	230 / 240 V	200 V	24 V AC
Tolerance band	200 – 260 V	170 – 220 V	20 – 27 V AC
2. Rated voltage	115 / 120 V	100 V	–
Tolerance band	100 – 130 V	85 – 110 V	–
Frequency	48 – 63 Hz		48 – 63 Hz
Power consumption (incl. primary head)	approx. 10 VA		approx. 10 VA
			approx. 8 W
When connected to functional extra-low voltage, 24 V, safety separation (PELV) is essential (to VDE 0100/VDE 0106 and IEC 364/IEC 536 or equivalent national standard).			
Housing			
Material		die-cast aluminium with polyurethane finish	
Ambient temperature		– 25 to + 60°C (– 13 to + 140°F)	
Protection category (IEC 529/EN 60 529)		IP 67, equivalent to NEMA 6	

10.5 Instrument nameplates

Separate signal converter in rotatable field housing

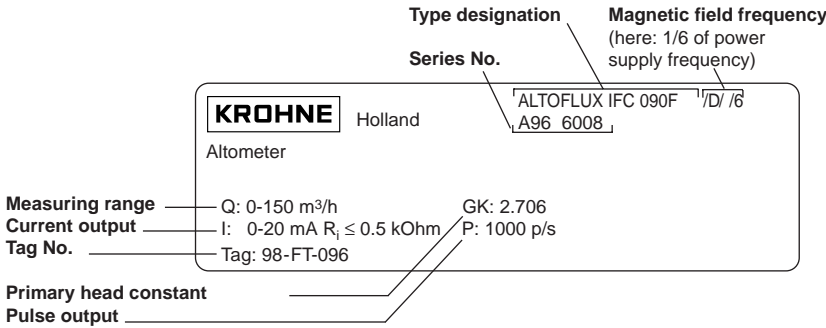

Compact flowmeters

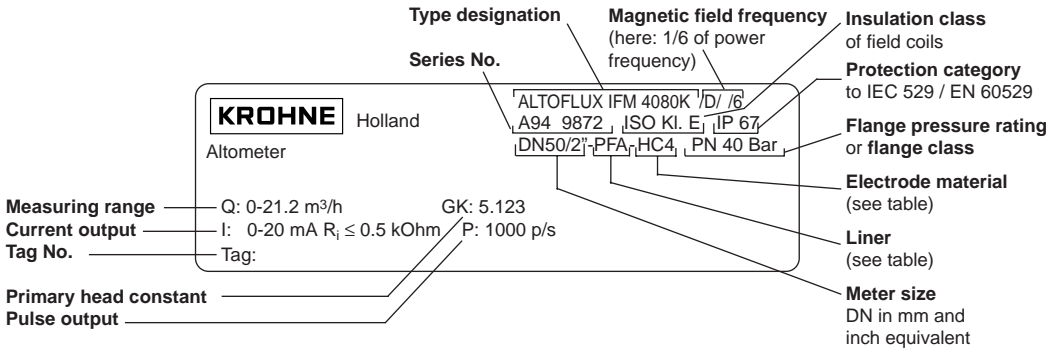

Abbreviations

Liner

AL	Fused aluminium oxide (99.7% Al ₂ O ₃)
H	Hard rubber
NE	Neoprene
PFA	Teflon®-PFA
PUI	Irethane
T	Teflon®-PTFE
W	Soft rubber
ZR	Zirconium oxide

Electrode material

C	conductive rubber compound
HB 2	Hastelloy B2
HC 4	Hastelloy C4
IN	Incoloy
M4	Monel 400
Ni	Nickel
PT	Platinum
TA	Tantalum
TI	Titanium
V4A	Stainless steel 1.4571 (SS 316 Ti)
xx / TC	xx with conductive PTFE compound (xx = base material, e.g. HC4)

Teflon® is a registered trademark of Du Pont

The flowmeter is designed for electrically conductive fluids.

Measurement is based on Faraday's law of induction, according to which a voltage is induced in an electrically conductive body which passes through a magnetic field. The following expression is applicable to the voltage.:

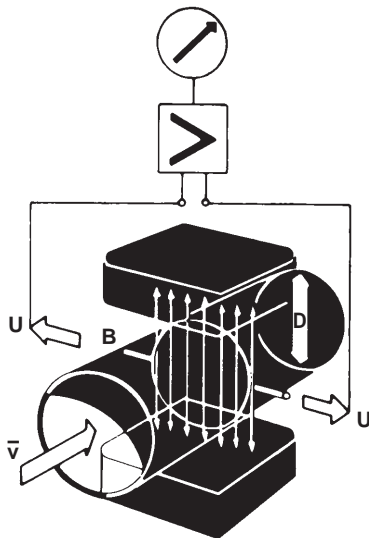

$$U = K \times B \times \bar{v} \times D$$

where:

U = induced voltage

K = an instrument constant

B = magnetic field strength

v = mean velocity

D = pipe diameter

Thus the induced voltage is proportional to the mean flow velocity, when the field strength is constant.

Inside the electromagnetic flowmeter, the fluid passes through a magnetic field applied perpendicular to the direction of flow. An electric voltage is induced by the movement of the fluid (which must have a minimum electrical conductivity). This is proportional to the mean flow velocity and thus to the volume of flow. The induced voltage signal is picked up by two electrodes which are in conductive contact with the fluid and transmitted to a signal converter for a standardized output signal.

This method of measurement offers the following advantages:

1. No pressure loss through pipe constriction or protruding parts.
2. Since the magnetic field passes through the entire flow area, the signal represents a mean value over the pipe cross-section; therefore, only relatively short straight inlet pipes $5 \times DN$ from the electrode axis are required upstream of the primary head.
3. Only the pipe liner and the electrodes are in contact with the fluid.
4. Already the original signal produced is an electrical voltage which is an exact linear function of the mean flow velocity.
5. Measurement is independent of the flow profile and other properties of the fluid.

The magnetic field of the primary head is generated by a square wave current fed from signal converter to the field coils.

This field current alternates between positive and negative values. Alternate positive and negative flowrate-proportional signal voltages are generated at the same frequency by the effect of the magnetic field, which is proportional to the current. The positive and negative voltages at the primary head electrodes are subtracted from one another in the signal converter. Subtraction always takes place when the field current has reached its stationary value, so that constant interference voltages or external or fault voltages changing slowly in relation to the measuring cycle are suppressed. Power line interference voltages coupled in the primary head or in the connecting cables are similarly suppressed.

12 Block diagram – signal converter

1 Input amplifier

- overdrive-proof signal processing, processes flow peaks up to 20 m/s (65 ft/s) and more rapidly and accurately
- digital signal processing and sequence control
- patented, high-resolution A/D converter, digitally controlled and monitored
- high signal-to-noise ratio through low-loss field power supply with high frequencies and currents

2 Field power supply

- the low-loss field power supply generates the pulsed, electronically controlled DC current for the magnetic coils of the primary head
- The high field current ensures a high signal level

3 Current output

- galvanically isolated from all other groups
- converts the digital output signal from the μP 3 microprocessor into a proportional current

4 Binary outputs and/or inputs

- galvanically isolated from other groups
- selectable input/output combinations
- pulse output (B1), passive FET optocouplers allow connection of electronic and electromechanical totalizers
- status output (B2) for limit value, error identification, or flow direction in forward/reverse flow mode (F/R) or measuring range identification in BA mode
- both outputs can also be used as control inputs

5 Display/operator control unit (option, D Version)

- large-size illuminated LC display
- 3 keys for operator control of the signal converter
- connection to the internal IMoCom bus
- unit can be retrofitted to basic devices (B Version)

6 IMoCom bus plug connector for connection of external control and test devices such as:

- adapter and CONFIG software for operation via MS-DOS PC

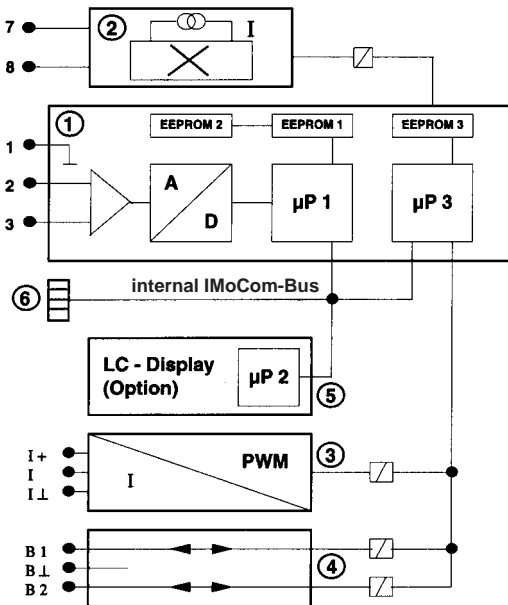

Keyword	Section No.	Fct. No.
A		
Abbreviations	1.3.2, 1.3.4, 2.1, 4.4	
Accuracies	10.3	
ADC = analog-digital converter	4.5, 12	
Ambient temperature	10.4	
Application	5.19	3.06
Automatic range change (BA)	4.4, 5.18	1.06, 1.07
B		
B1/B2 output/input terminals	2.1, 2.6, 5.16	3.07 (1.06, 1.07)
BA = automatic range change	4.4, 5.18	1.06, 1.07
Block diagram IFC 090	12	
B version (basic)	4, 6.2, 8.4, 10.4	
C		
C = control input	2.5, 2.6, 5.9	1.06, 1.07, 3.07
Cable length	1.3.4	
Changeover, power supply	8.1	
Characteristics of outputs	5.15	
Clearing error messages	4.6	
Coding for entry into setting level	5.11	3.04
CONFIG software	6.2	
Connecting & operating points		
– front panel power supply	4.2	
– PCB amplifier	8.9	
– PCB power supply	8.9	
Connection diagrams		
– GS8A simulator	7.6	
– Outputs/inputs	2.6	
– Power supply	1.2, 1.3.5	
Control input C		
– connection	2.6	1.06, 1.07, 3.07
– description	2.5, 2.6, 5.9	1.06, 1.07, 3.07
Conversion factor		
– Quantity (volume)	4.4 + 5.12	3.05
– Time	4.4 + 5.12	3.05
Current output I	2.2, 5.6	1.05
Cut-off "off" value (SMU OFF)	5.3	1.03
Cut-off "on" value (SMU ON)	5.3	1.03
D		
Data	4.4	
Data column	4.1-4-3	
Data errors	4.5	
Dimensions		
– IFC 090 F	10.2	
– ZD	10.2	
Display	4.2, 5.4, 8.4	1.04
DN = meter size in mm	4.4	3.02
DS, signal cable A	1.3.1	
E		
EC = electronic totalizer	2.3, 2.6, 5.8	1.06
Electrical connection		
– GS8A simulator	7.6	
– outputs and inputs	2.6	
– power supply	1.1, 1.3.5	
Electromagnetic compatibility	page 0/4	
EMC = electromechanical totalizer	2.3, 2.6, 5.8	1.06
EN technical standards	page 0/4	
Error	4.5	
Error list	4.5	
Error (messages)	4.5	
– cancel	4.5	
– limits	10.3	
– reset / delete	4.6	
External range change	4.4, 5.18	1.06, 1.07
External totalizers	2.3, 2.6, 5.7	1.06

Keyword	Section No.	Fct. No.
F		
F = forward flow	4.4, 5.3, 5.14	1.04-1.07
F1, F2 = fuses	8.1, 8.5	
Factory settings	3.2	
Fatal error	4.5	
FE = functional ground	1.2, 1.3.3, 1.3.5	
Field power supply	5.12, 10.4, 12	3.02
Flow		
– pulsating	6.4	3.06
– rapid changes	6.5	
Flow direction	4.4, 5.1, 5.14	3.02
Flowrate, rapid changes	6.5	
Flow rate (Q)	4.4, 5.1	3.02
Flow velocity v	4.4, 5.1	3.02
Frequency (pulse output)		
– F_{max}	5.7	1.06, 3.07
– F_{min}	5.7	1.06, 3.07
Frequency output, see pulse output P	2.3, 5.7	1.06, 3.07
Full-scale range $Q_{100\%}$	4.4, 5.1, 5.14	1.01, 3.02
Function(s)	4.4	
Function of keys	4.1-4.3	
Functional checks	7.1 et seq.	
– primary head	7.5	
– setpoint display values	7.6	
– system	7.4	
– test full scale range	7.2	2.01
– zero	7.1	3.03
Functional ground FE	1.2, 1.3.3, 1.3.5	
Functions column	4.1-4.3	
Fuses (F . . .)	8.1, 8.5	
G		
GK = primary (head) constant	4.4, 5.11	3.02
Grounding primary head	1.3.3	
GS 8A = primary (head) simulator	7.6	
H		
Hand held bar magnet	4.2	
Hand held terminal	6.2	
Hardware information	7.3	2.02
HART	6.7	
Hazardous duty areas (Ex)	6.1, page 0/4	
I		
I = current (analog) output	2.3, 5.6	1.05
IEC technical standards	page 0/4	
IMoCom bus (plug)	6.2, 8.9, 12	
Initial start-up	3	
Input (programming)	4.1 et seq.	
Instrument nameplates	10.5	
Interface RS 232	6.2, 10.4	
Intermediate connection box (ZD)	1.3.5, 10.2	
Internal electronic totalizer	2.4, 5.5, 5.7	1.04
K		
Keys	4.1-4.3	
Keystroke combinations for		
– entry into setting level	4.1-4.3	3.04
– error cancellation	4.6	
– quitting setting level	4.1-4.3	
– totalizer reset	4.6	
L		
Language of display texts	5.10	3.01
LCD display, see display	4.2, 4.4, 5.4	1.04
Limit message	4.4, 5.8	1.07
Line voltage, see power supply		
Low-flow cutoff (SMU)	4.4, 5.3	1.03

Keyword	Section No.	Fct. No.
M		
Magnetic field frequency	4.4 + 5.11	3.02
Magnetic sensors	4.2	
Main menu column	4.1	
Main menus	4.1 to 4.3	1.00, 2.00, 3.00
Mass flow measurement, see user defined unit	4.4, 5.13	
Measuring principle	11	
Menu	4.1, 4.4	
Meter size (DN)	4.4, 5.12	3.02
N		
Numerical format, display	5.4, 5.5	1.04
O		
Option = optional equipment	6.2, 10.4	
Order numbers	9	
Outputs		
– characteristics	5.15	
– connection diagrams	2.6	
– setting	4.4	
– – I	5.6	1.05
– – P	5.7, 5.16	1.06, 3.07
– – S	5.8, 5.16	1.06, 1.07, 3.07
– voltage stable when measuring tube empty	6.3	
Overflow, display	5.5	1.04
Overranged		
– I (current output)	2.2, 2.6, 5.6, 5.8	1.06, 1.07
– P (pulse output)	2.3, 2.6, 5.7, 5.8	1.06, 1.07
Overvoltage class	2.1	
P		
P = pulse output	2.4, 4.4, 5.7	1.06
PCB = printed circuit boards	8.9	
PC software	6.2	
PE = protective conductor	1.2	
Power supply (= line voltage)		
– changeover	8.2	
– connection	2.1, 10.4	
– consumption	10.4	
– failure	4.5, 7.4	
– frequency	1.2, 10.4	
– voltage	1.2, 10.4	
Primary constant, see GK	4.4, 5.12	3.02
Primary head		
– constant, see GK	4.4, 5.12	3.02
– simulator GS 8A	7.6	
– testing	7.5	
Primary simulator, see GS 8A	7.6	
Printed circuit boards, see PCB	8.9	
Program organization	4.1	
Programming = input	4.1-4.3	
Programming mode, entry into	4.1-4.3	
Protective conductor PE	1.2	
Pulsating flow	6.4, 6.5, 6.6	3.06
Pulse output P	2.3, 4.4, 5.7	1.06
Pulse width	4.4, 5.7	1.06
Pulses per unit time	4.4, 5.7	1.06
Pulses per unit volume	4.4, 5.7	1.06
Q		
Q = flow rate	4.4, 5.1	1.01, 3.02
Q _{100%} = full-scale range	4.4, 5.1	1.01, 3.02
R		
R = reverse flow	4.4, 5.14	1.04-1.07
Range change		
– automatic	2.5, 2.6, 5.8, 5.18	1.06, 1.07
– external	2.5, 2.6, 5.9, 5.18	1.06, 1.07
Range setting	4.4, 5.1, 5.12	1.01, 3.02
Replacement		
– electronic unit	8.7	
– power fuses	8.1	
Reset totalizers	4.6	
Reverse flow (R)	4.4, 5.14	1.04-1.07
Revert to		
– functions column	4.1-4.3	
– main menu column	4.1-4.3	
– measuring mode	4.1-4.3	
– submenu column	4.1-4.3	
RS 232 interface	6.2	

Keyword	Section No.	Fct. No.
S		
S = Status output	2.4, 4.4, 5.8	1.06, 1.07, 3.07
Safety isolation	2.1	
Setting level	4.1-4.4	1.00 et seq., 2.00 et seq., 3.00 et seq.
Signal converter IFC 090		
– accuracies	10.3	
– cable A	1.3.1	
– changeover, power supply	8.2	
– connecting & operating points	4.2, 8.9	
– connection to power	1.2	
– functional checks	7.1-7.6,	
– fuses, power	8.5	
– mounting location	1.1	
– nameplates	10.5	
– operator control	4.1-4.3	
– power consumption	10.4	
– printed circuit boards	8.9	
– spare parts	9	
– technical data	10.1-10.4	
Simulator GS 8A	7.6	
SMU = low-flow cutoff	4.4, 5.3	1.03
Software	6.2	
Spare parts, see order numbers	9	
Status output S	2.4, 4.4, 5.8	1.06, 1.07, 3.07
T		
T = time constant	5.2	1.02
Technical data		
– accuracies	10.3	
– dimensions & weights	10.2	
– signal converter IFC 090	10.1-10.4	
Terminals B1/B2	2.1, 2.6, 5.16	3.07 (1.06, 1.07)
Tests, see functional checks	7.1 et seq.	
Time constant (T)	5.2	1.02
Totalizer (internal electronic)	2.3, 5.7	1.06, 3.07
Trip point	2.4, 2.6, 5.8	1.06, 1.07
Troubleshooting, see functional checks	7.1 et seq.	
U		
Units for		
– display	4.4, 5.4	1.04
– flow	4.4, 5.1	1.01
– P	4.4, 5.7	1.06
User-defined unit	4.4, 5.13	3.05
V		
v = flow velocity	4.4, 5.1	3.02
VDE standards	page 0/4	
W		
Weights, see dimensions	10.2	
Z		
Zero check (adjustment)	7.1	3.03
ZD, intermediate connection box	1.3.5, 10.2	

If you need to return flowmeters for testing or repair to Krohne

Your electromagnetic flowmeter

- has been carefully manufactured and tested by a company with ISO 9001 certification
- and volumetrically calibrated in one of the world's most accurate test rigs.

If installed and operated in accordance with these operating instructions, your flowmeter will rarely present any problems.

Should you nevertheless need to return a flowmeter for checkout or repair, please pay strict attention to the following points:

Due to statutory regulations concerning protection of the environment and the health and safety of our personnel, Krohne may only handle, test and repair returned flowmeters that have been in contact with liquids if it is possible to do so without risk to personnel and environment. This means that Krohne can only service your flowmeter if it is accompanied

by a certificate in line with the following model confirming that the flowmeter is safe to handle.

If the flowmeter has been operated with toxic, caustic, flammable or water-endangering liquids, you are kindly requested

- to check and ensure, if necessary by rinsing or neutralizing, that all cavities in the flowmeter are free from such dangerous substances.
(Directions on how you can find out whether the primary head has to be opened and then flushed out or neutralized are obtainable from Krohne on request.)
- to enclose a certificate with the flowmeter confirming that the flowmeter is safe to handle and stating the liquid used.

Krohne regret that they cannot service your flowmeter unless accompanied by such a certificate.

SPECIMEN certificate

Company:

Address:

Department:

Name:

Tel. No.:

The enclosed electromagnetic flowmeter

Type:

Krohne Order No. or Series No.:

has been operated with the following liquid:

Because this liquid is

water-endangering * / toxic * / caustic * / flammable *

we have

– checked that all cavities in the flowmeter are free from such substances *

– flushed out and neutralized all cavities in the flowmeter *

(* delete if not applicable)

We confirm that there is no risk to man or environment through any residual liquid contained in this flowmeter.

Date: Signature:

Company stamp: